



**Pb-free
HEAT**



1111C Series

Single Color Ultra High Brightness Type

Features

Package	1608 (h=0.7mm) Type, Milky White resin
Product features	<ul style="list-style-type: none"> • Outer Dimension 1.6 x 0.8 x 0.7mm (L x W x H) • Temperature range Storage Temperature : -40 ~ 100 Operating Temperature : -40 ~ 85 • Lead-free soldering compatible • RoHS compliant
Dominant wavelength	Blue : 470nm(SB,UB) Blue Green : 508nm(UC) Green : 530nm(SG,UG) Yellow : 590nm(UY) Red : 630nm(UR)
Half Intensity Angle	SB, SG : x = 150 deg., y =150 deg. UB, UC, UG : x = 150 deg., y =165 deg. UY, UR : x = 150 deg., y =140 deg.
Die materials	SB,SG,UB,UC,UG : InGaN UY,UR : AlGaInP
Rank grouping parameter	Sorted by luminous intensity and wavelength per rank taping
Assembly method	Auto pick & place machine (Auto Mounter)
Soldering methods	Reflow soldering
Taping and reel	4,000pcs per reel in a 8mm width tape. (Standard) Reel diameter: 180mm
ESD	InGaN : Up to 1kV(HBM), AlGaInP : Up to 2kV (HBM)

Recommended Applications

Communication Machine, Electric Household Appliances, OA/FA, Other General Applications

Color and Luminous Intensity

(Ta=25)

Part No.	Material	Emitted Color	Lens Color	Dominant Wavelength		Luminous Intensity		
				d (nm)		Iv (mcd)		
				TYP.	I _F (mA)	MIN.	TYP.	I _F (mA)
SB1111C-0005	InGaN	Blue	Milky White	470	5	10	20	5
UB1111C	InGaN	Blue		470	10	17	34	10
UC1111C	InGaN	Blue Green		508	10	80	160	10
SG1111C-0005	InGaN	Green		530	5	33	90	5
UG1111C	InGaN	Green		530	10	96	160	10
UY1111C	AlGaInP	Yellow		590	20	50	100	20
UR1111C	AlGaInP	Red		630	20	50	100	20

Absolute Maximum Ratings

(Ta=25)

Item	Symbol	Absolute Maximum Ratings							Unit
		SB	SG	UB	UC	UG	UY	UR	
Power Dissipation	P_d	55	78	78	78	78	87	87	mW
Forward Current	I_F	15	20	20	20	20	30	30	mA
Pulse Forward Current ¹	I_{FRM}	48	48	48	48	48	100	100	mA
Derating (Ta=25 or higher)	I_F	0.20	0.26	0.28	0.28	0.28	0.43	0.43	mA/
	I_{FRM}	0.64	0.64	0.69	0.69	0.69	1	1	mA/
Reverse Voltage	V_R	5	5	5	5	5	5	5	V
Operating Temperature	T_{opr}	-40 ~ +85							
Storage Temperature	T_{stg}	-40 ~ +100							

¹ I_{FRM} Measurement condition : Pulse Width 1ms., Duty 1/20. (UY,UR : Duty 1/10)

Electro-Optical Characteristics (SB,SG)

(Ta=25)

Item	Conditions	Symbol	Characteristics			Unit
				SB	SG	
Forward Voltage	I _F =5mA	V _F	TYP.	2.9	3.0	V
			MAX.	3.2	3.2	
Reverse Current	V _R =5V	I _R	MAX.	100	100	μ A
Peak Wavelength	I _F =5mA	λ _p	TYP.	465	525	nm
Dominant Wavelength	I _F =5mA	λ _d	TYP.	470	530	nm
Spectral Line Half Width	I _F =5mA		TYP.	15	30	nm
Half Intensity Angle	I _F =5mA	2θ	TYP.	150(x)	150(x)	deg.
				150(y)	150(y)	

x : Product long side axis, y : Product short side axis

Electro-Optical Characteristics (UB,UC,UG)

(Ta=25)

Item	Conditions	Symbol	Characteristics			Unit	
				UB	UC		UG
Forward Voltage	I _F =10mA	V _F	TYP.	3.4	3.4	3.4	V
			MAX.	3.9	3.9	3.9	
Reverse Current	V _R =5V	I _R	MAX.	100	100	100	μ A
Peak Wavelength	I _F =10mA	λ _p	TYP.	465	502	522	nm
Dominant Wavelength	I _F =10mA	λ _d	TYP.	470	508	530	nm
Spectral Line Half Width	I _F =10mA		TYP.	26	30	35	nm
Half Intensity Angle	I _F =10mA	2θ	TYP.	150(x)	150(x)	150(x)	deg.
				165(y)	165(y)	165(y)	

x : Product long side axis, y : Product short side axis

Electro-Optical Characteristics (UY,UR)

(Ta=25)

Item	Conditions	Symbol	Characteristics		Unit	
			UY	UR		
Forward Voltage	I _F =20mA	V _F	TYP.	2.2	2.2	V
			MAX.	2.8	2.8	
Reverse Current	V _R =5V	I _R	MAX.	100	100	μ A
Peak Wavelength	I _F =20mA	ρ	TYP.	592	641	nm
Dominant Wavelength	I _F =20mA	d	TYP.	590	630	nm
Spectral Line Half Width	I _F =20mA		TYP.	18	18	nm
Half Intensity Angle	I _F =20mA	2 1/2	TYP.	150(x)	150(x)	deg.
				140(y)	140(y)	

x: Product long side axis, y: Product short side axis

Luminous Intensity Rank (Unit : mcd)

(Ta=25)

Tolerance : +/-10%

Rank	I_V (mcd)			
	SB		SG	
	$I_F=5mA$		$I_F=5mA$	
	MIN.	MAX.	MIN.	MAX.
BA	10	15	/	
BB	15	22		
BC	22	33		
BD	33	47	33	47
BE	47	-	47	68
BF	/		68	100
CA			100	150
CB			150	220

Rank	I_V (mcd)									
	UB		UC		UG		UY		UR	
	$I_F=10mA$		$I_F=10mA$		$I_F=10mA$		$I_F=20mA$		$I_F=20mA$	
	MIN.	MAX.	MIN.	MAX.	MIN.	MAX.	MIN.	MAX.	MIN.	MAX.
A	/		80	112	/		50	100	50	100
B			96	136			70	140	70	140
C			112	160			96	136	100	200
D	17	24	136	192	112	160	140	280	140	280
E	20	28	160	224	136	192	200	400	200	400
F	24	34	192	320	160	224	280	-	280	-
G	28	40	224	-	192	272	/		/	
H	34	48	/		224	320				
J	40	56			272	-				
K	48	-			/		/			

Please contact our sales staff concerning rank designation.

Color Tone Groups (d)

(Ta=25)

Tolerance : +/-3nm

Rank	Dominant Wavelength d (nm)			
	SB		SG	
	I _F =5mA		I _F =5mA	
	MIN.	MAX.	MIN.	MAX.
2	465	470	520	532
3	470	475	532	545

Rank	Dominant Wavelength d (nm)					
	UB		UC		UG	
	I _F =10mA		I _F =10mA		I _F =10mA	
	MIN.	MAX.	MIN.	MAX.	MIN.	MAX.
-	460	480	500	520	520	545

Rank	Dominant Wavelength d (nm)			
	UY		UR	
	I _F =20mA		I _F =20mA	
	MIN.	MAX.	MIN.	MAX.
A	580	585	620	630
B	584	589	628	638
C	588	593	/	
D	592	597		
E	596	601		

Please contact our sales staff concerning rank designation.

Technical Data (SB)

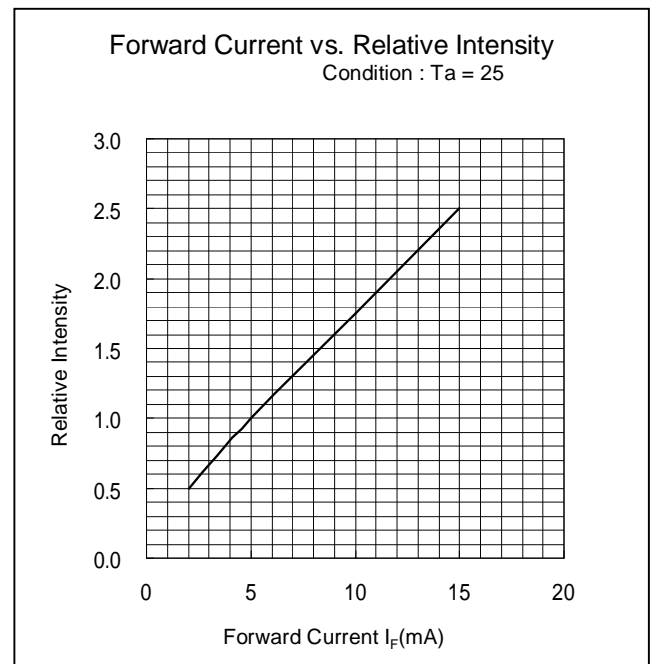
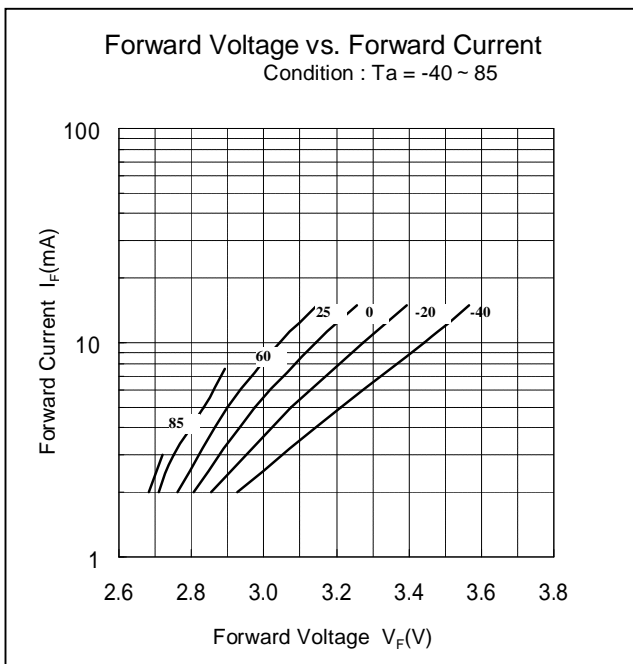
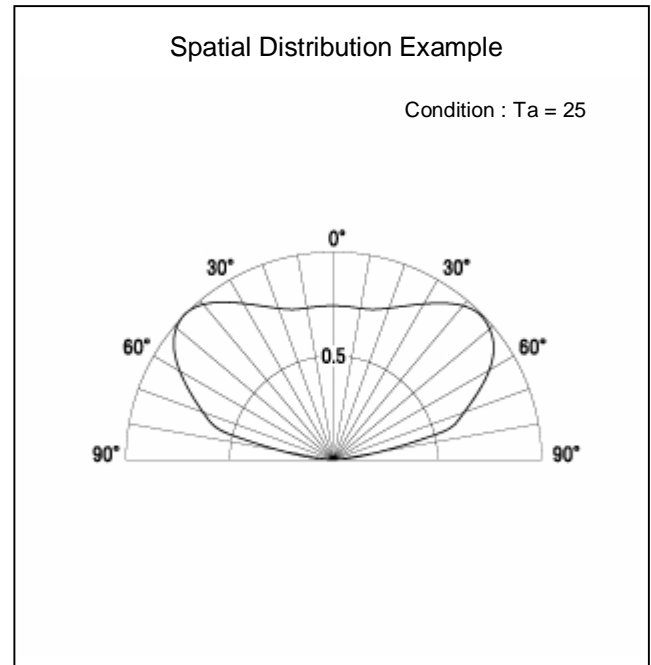
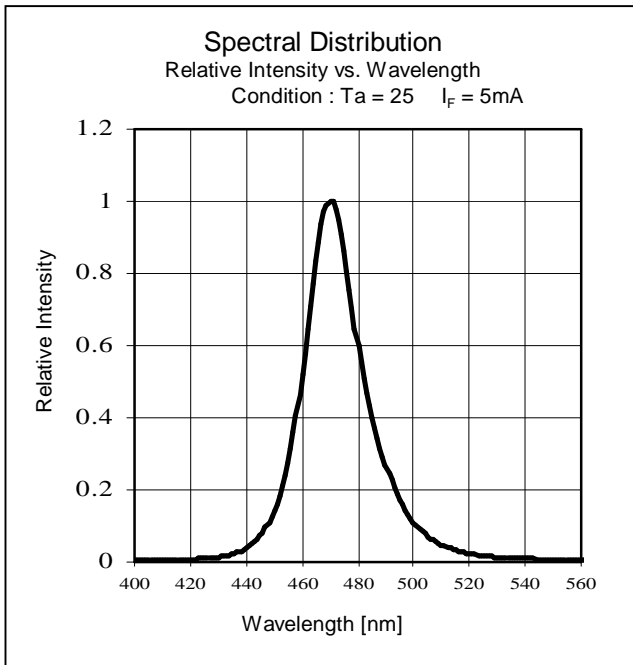

Technical Data (SB)

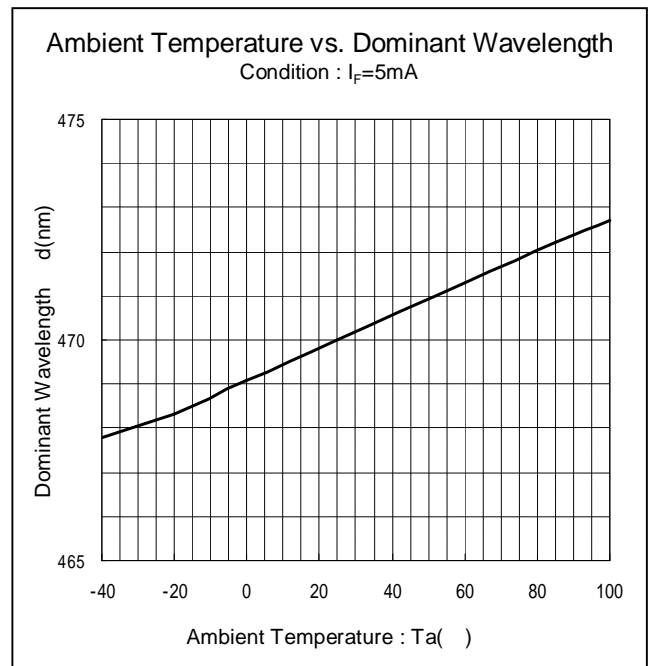
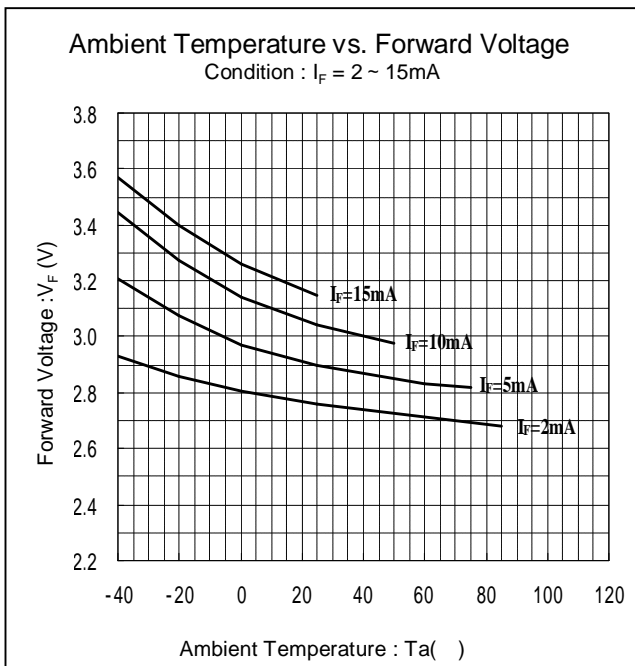
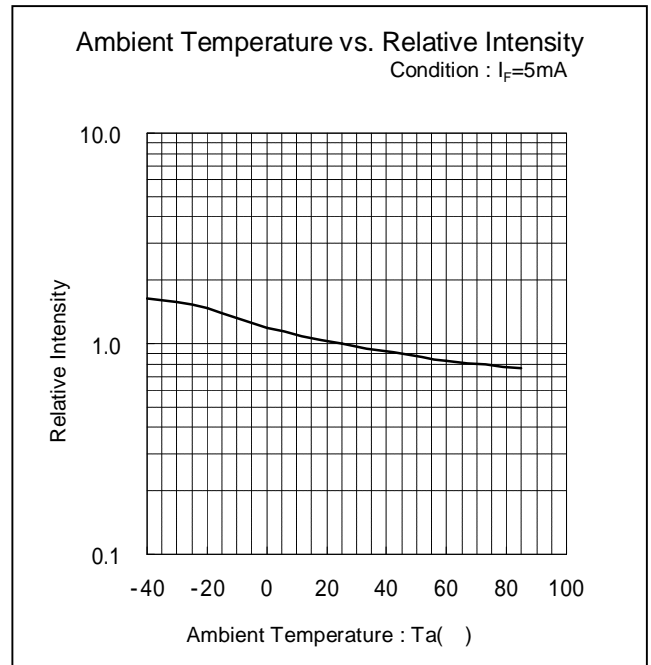
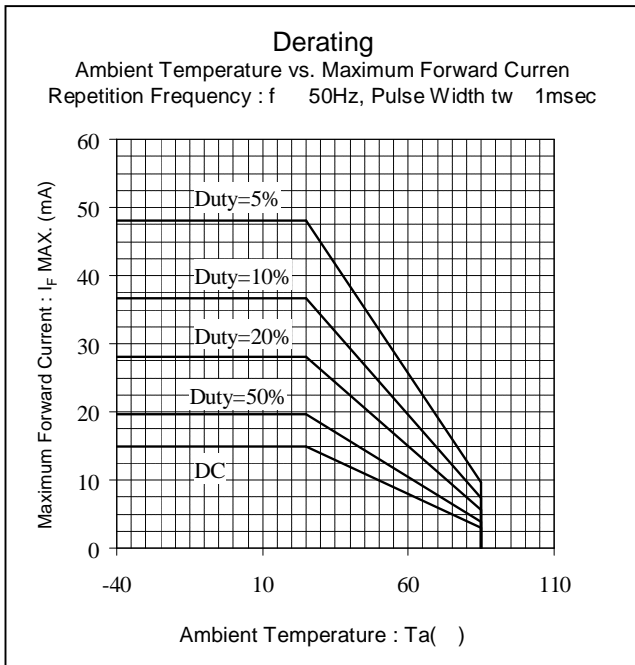

Technical Data (SB)

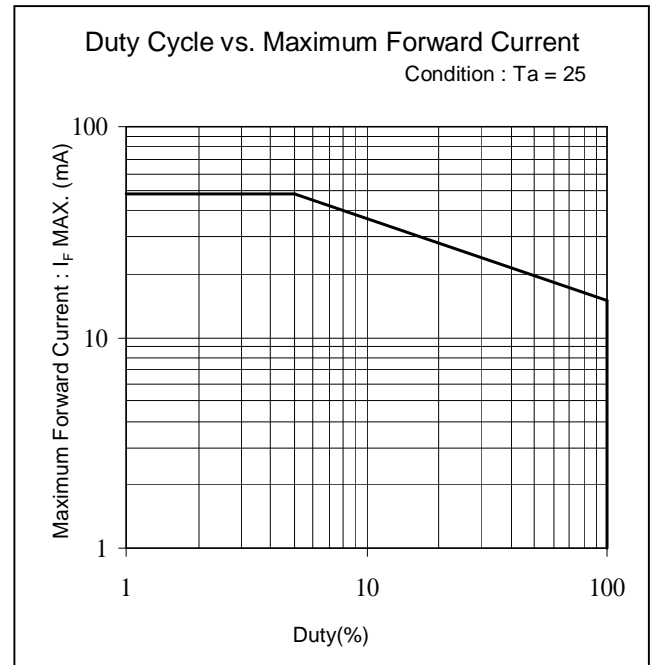
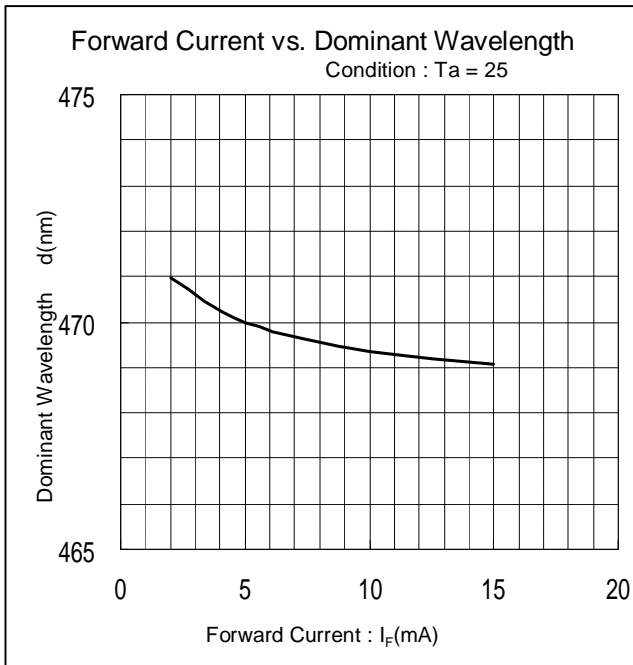

Technical Data (SG)

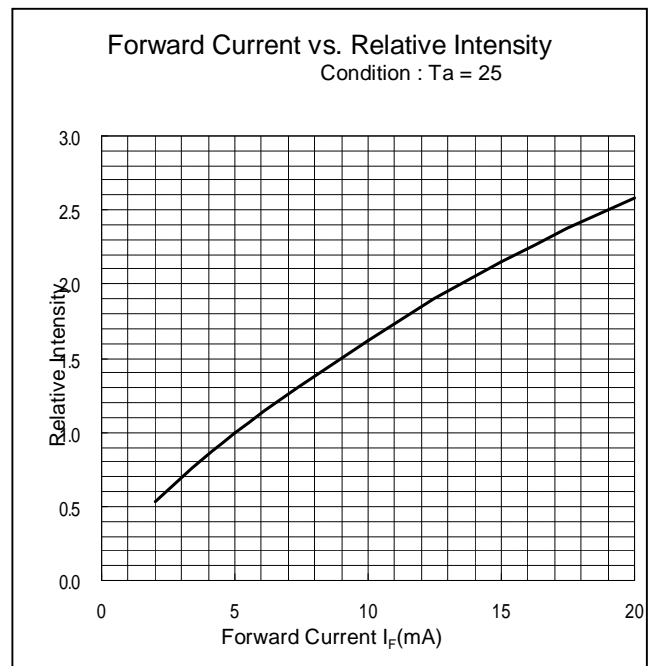
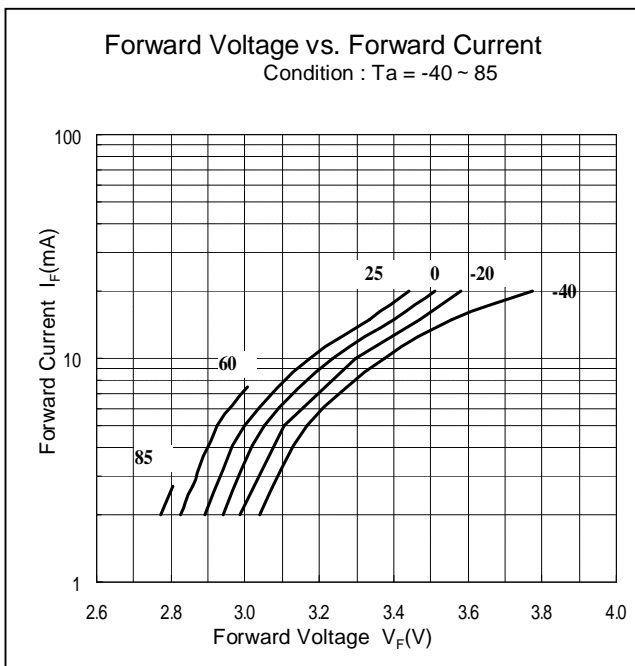
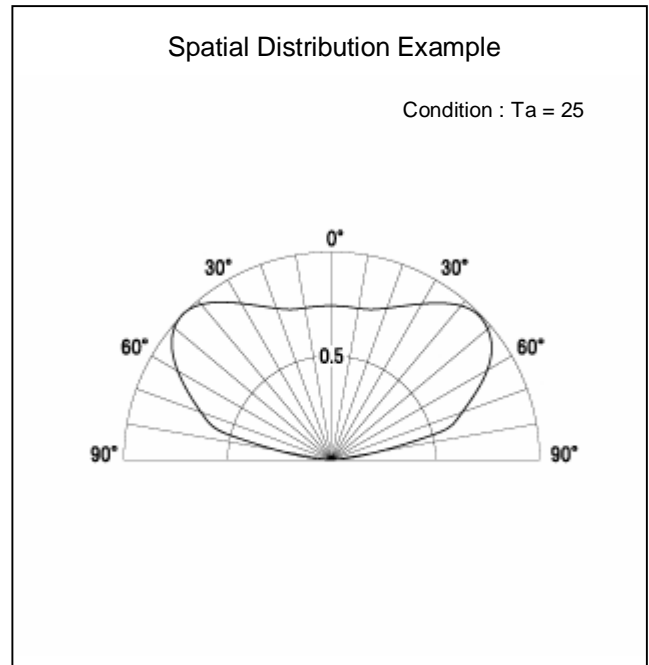
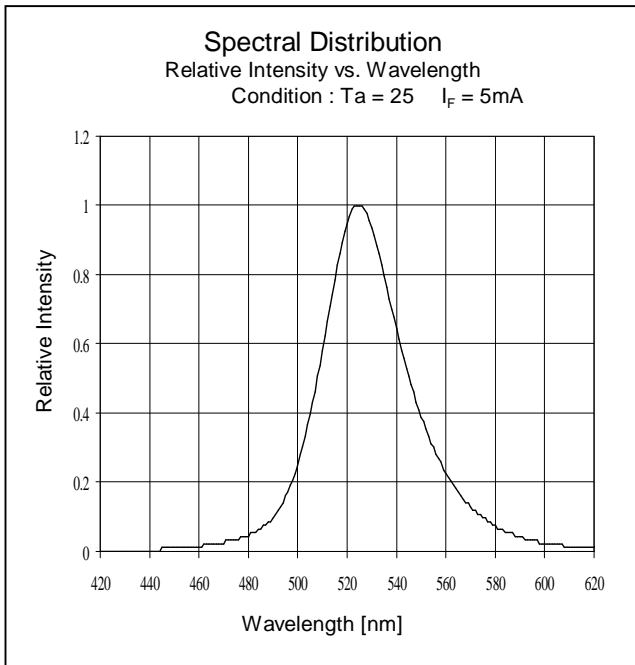

Technical Data (SG)

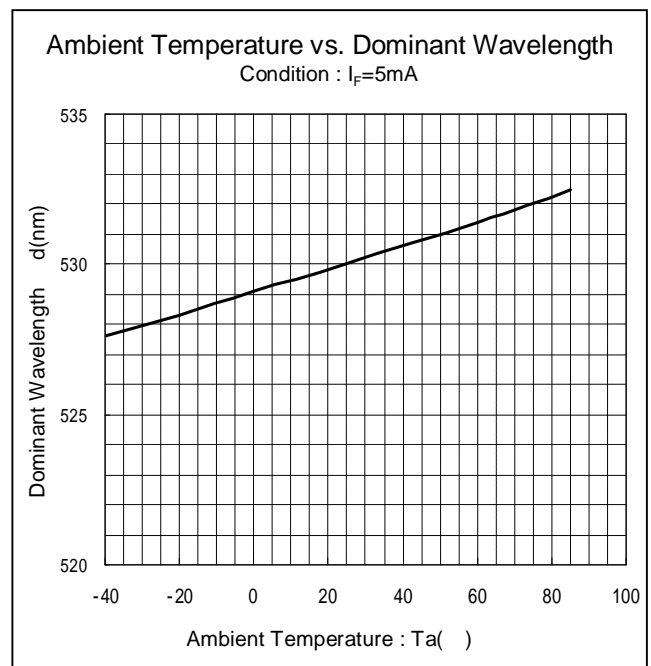
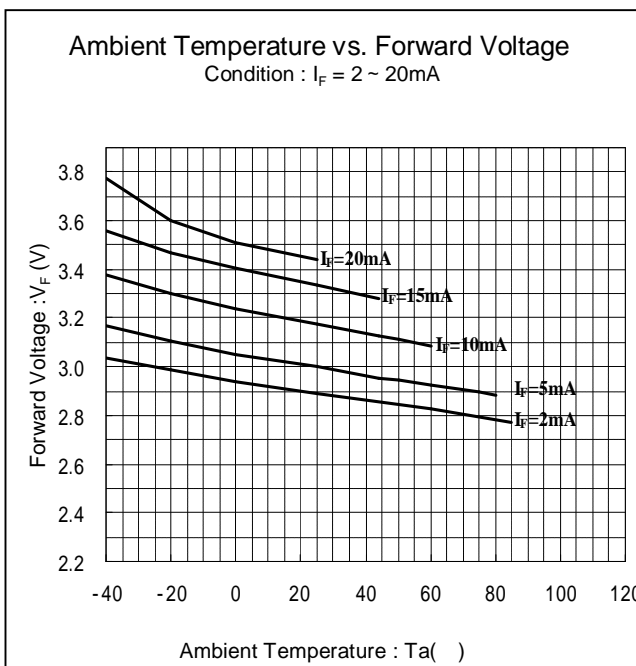
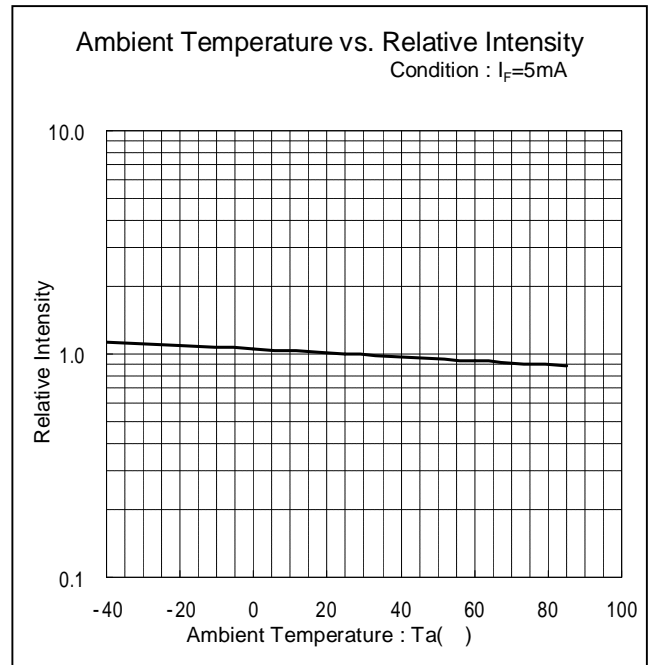
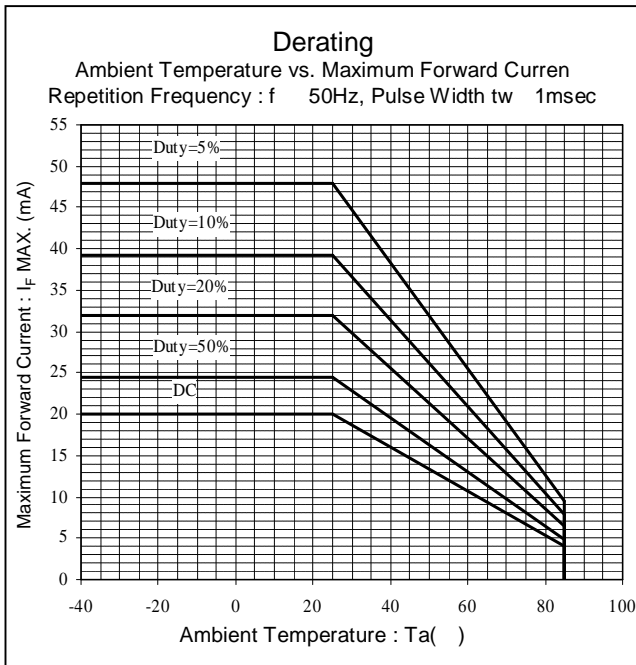

Technical Data (SG)

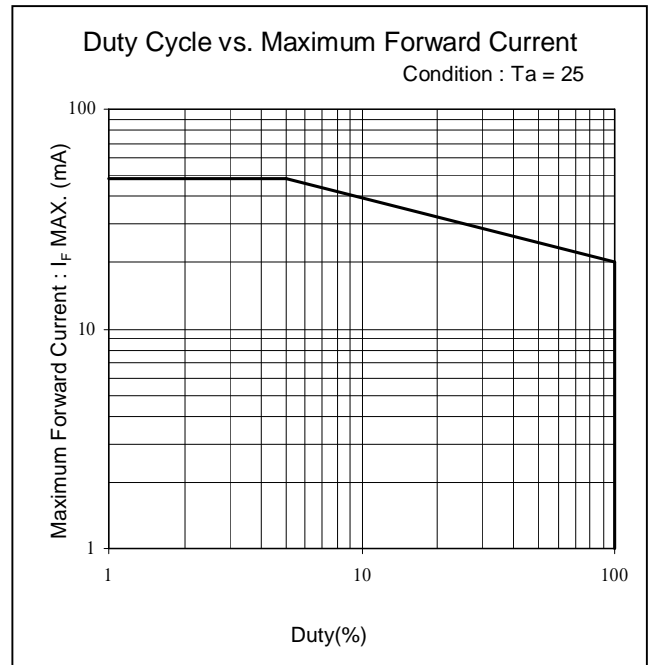
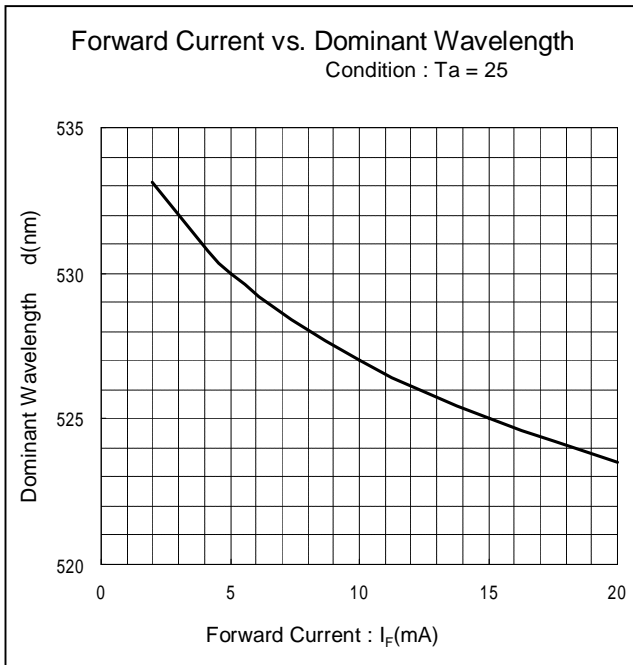

Technical Data (UB)

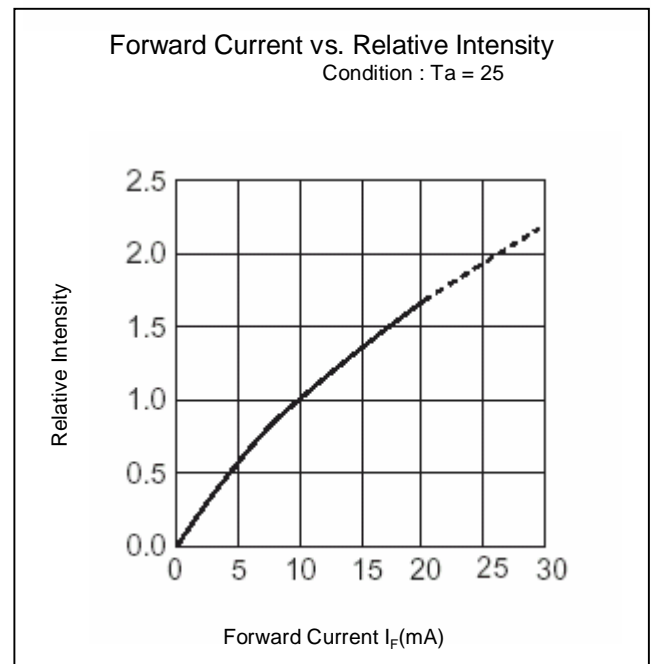
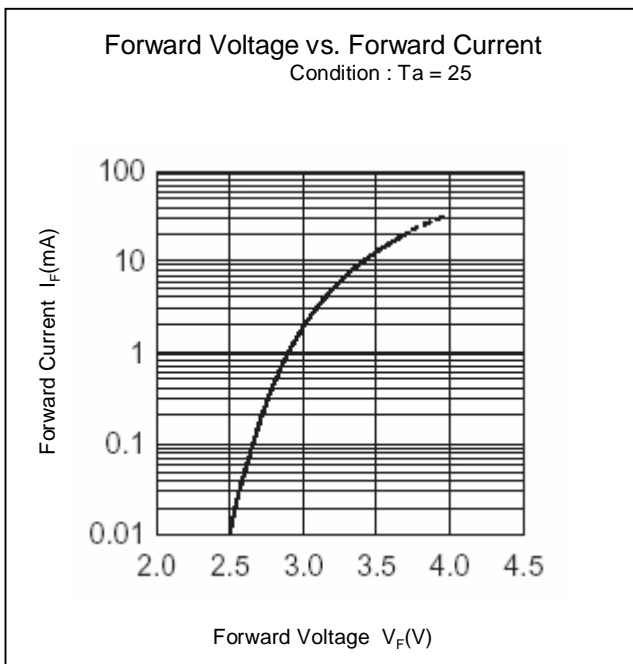
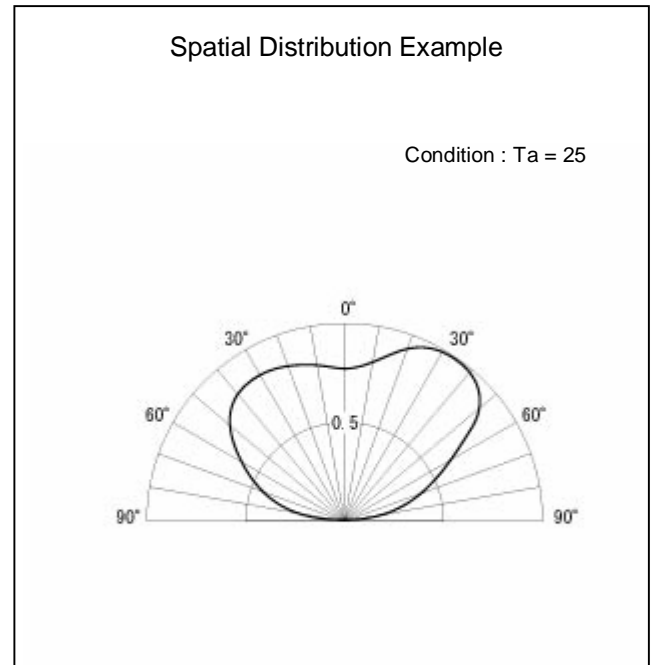
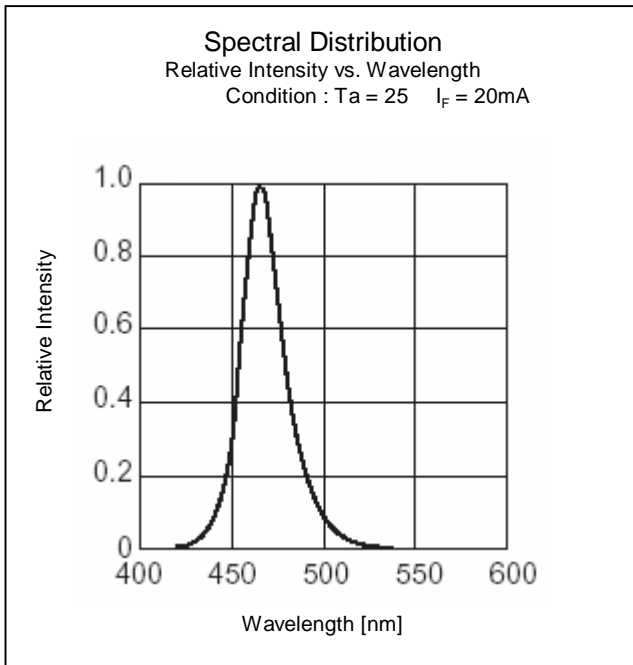

Technical Data (UB)

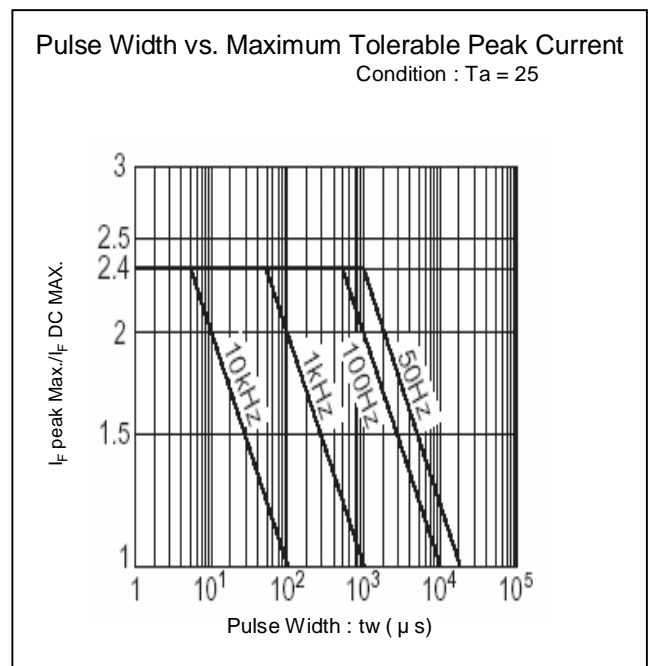
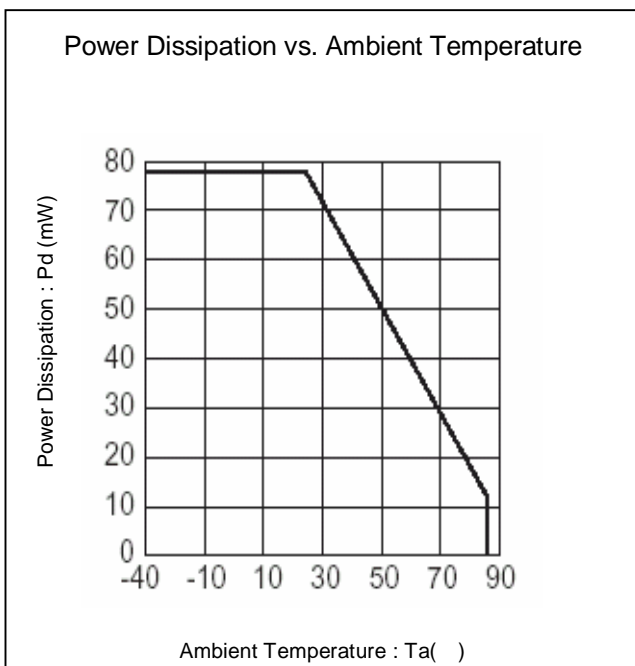
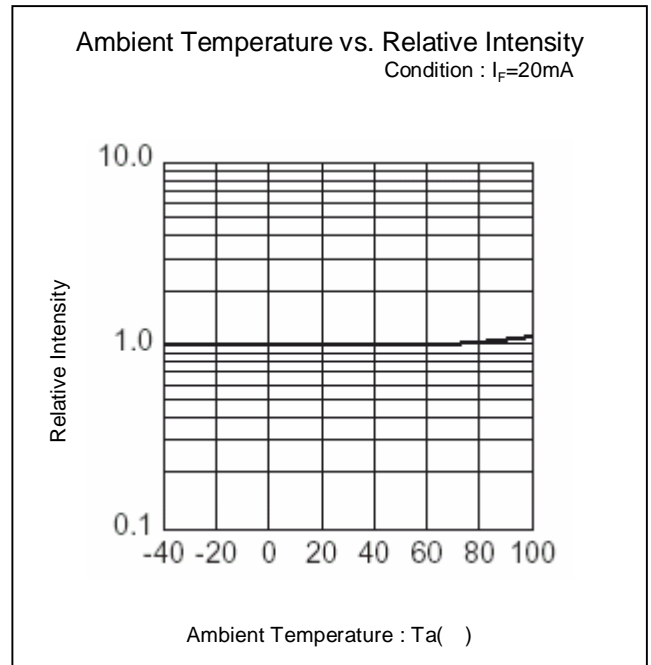
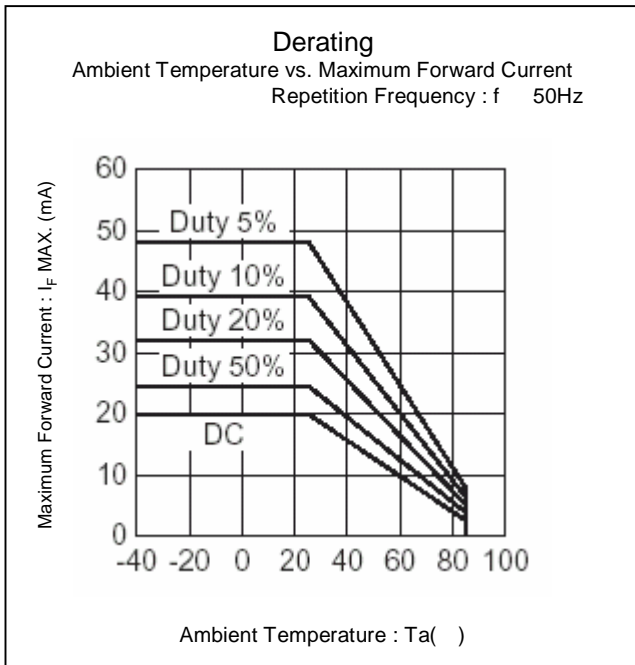

Technical Data (UC)

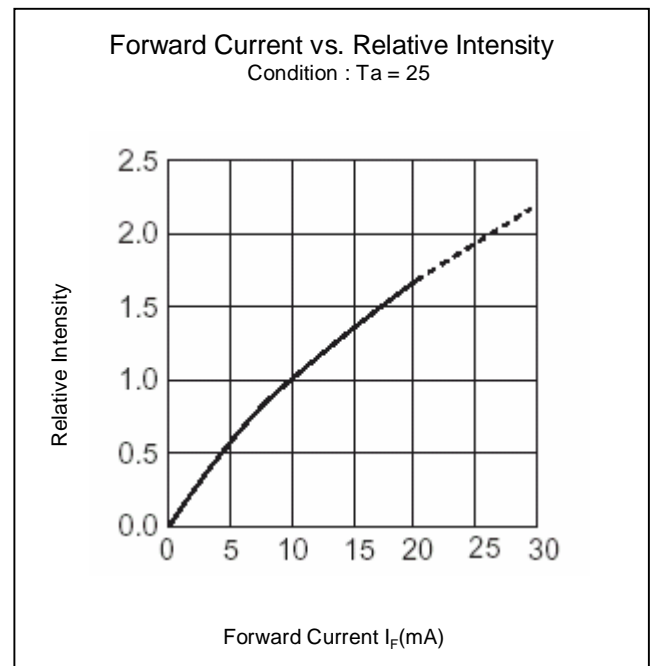
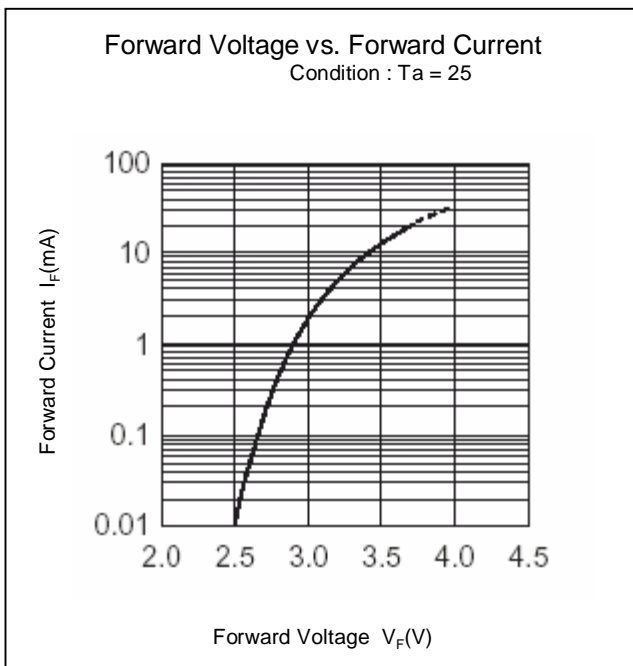
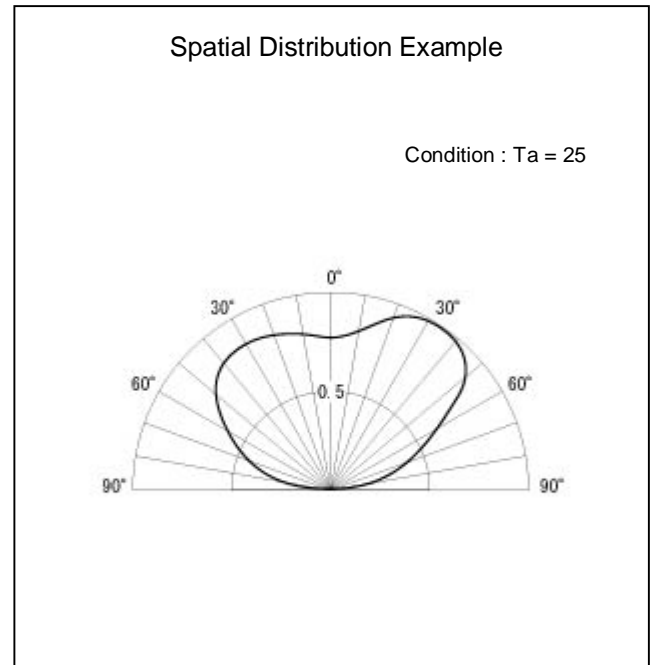
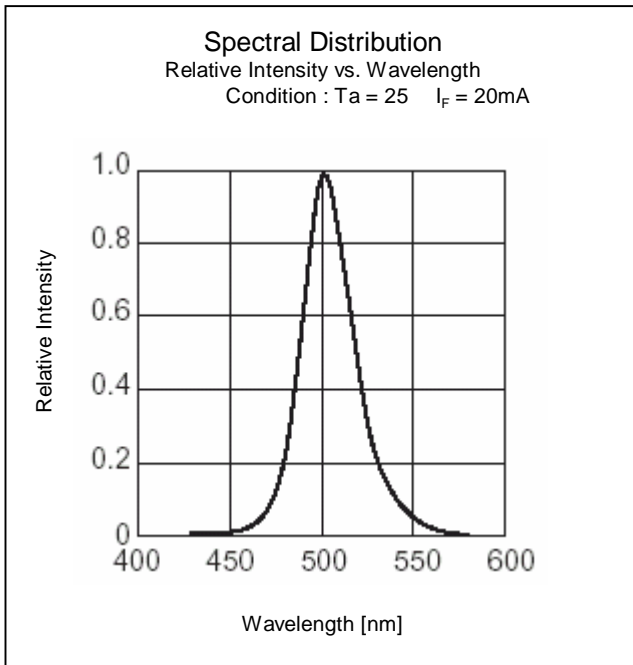

Technical Data (UC)

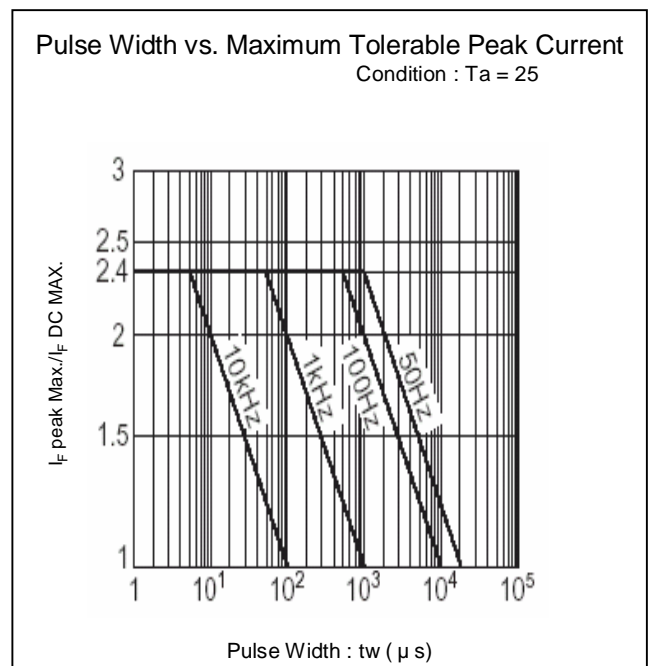
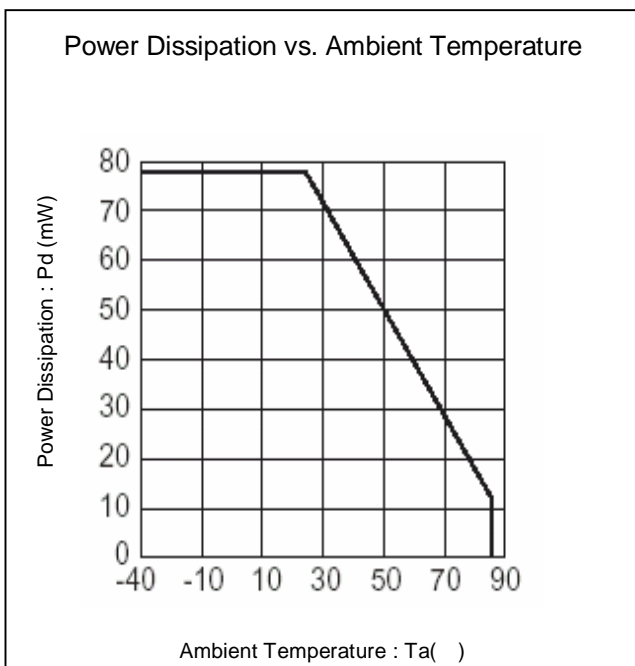
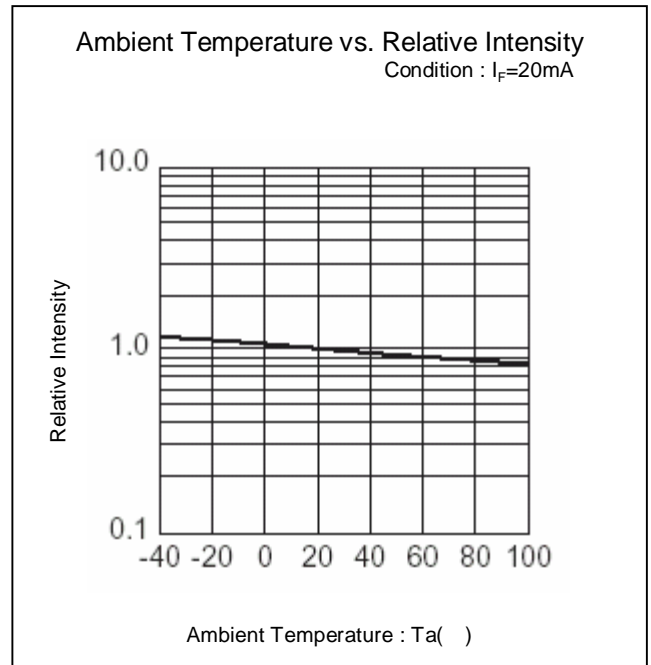
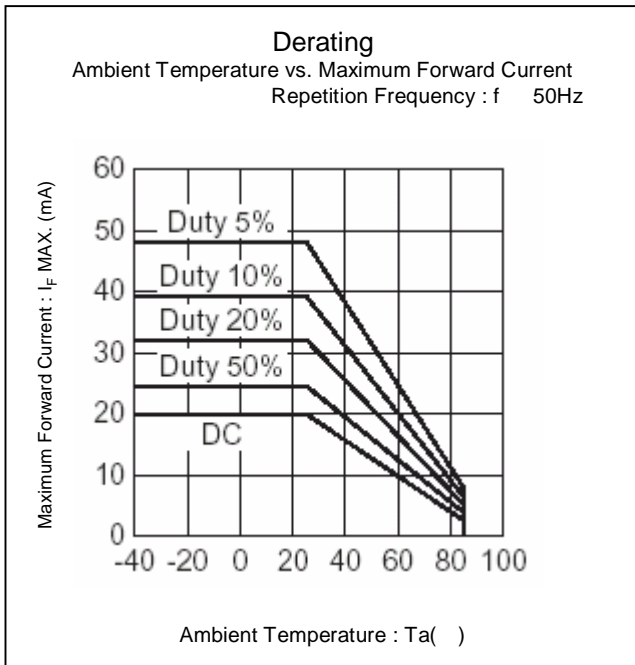

Technical Data (UG)

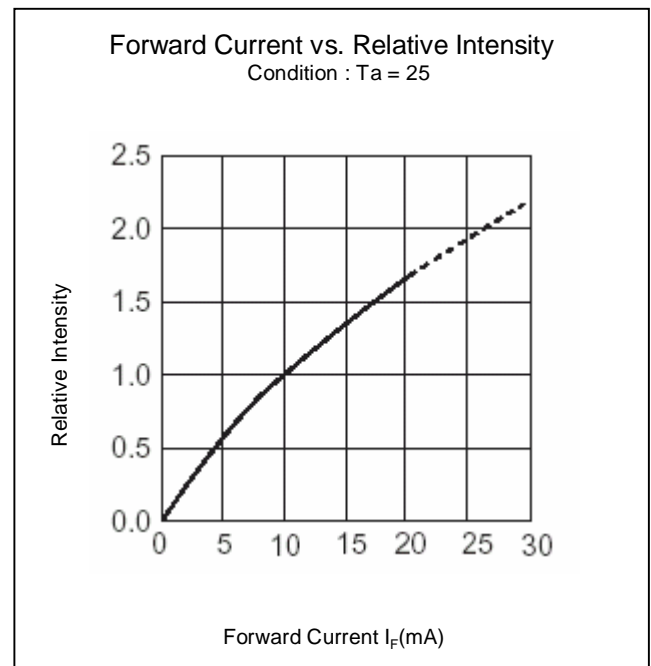
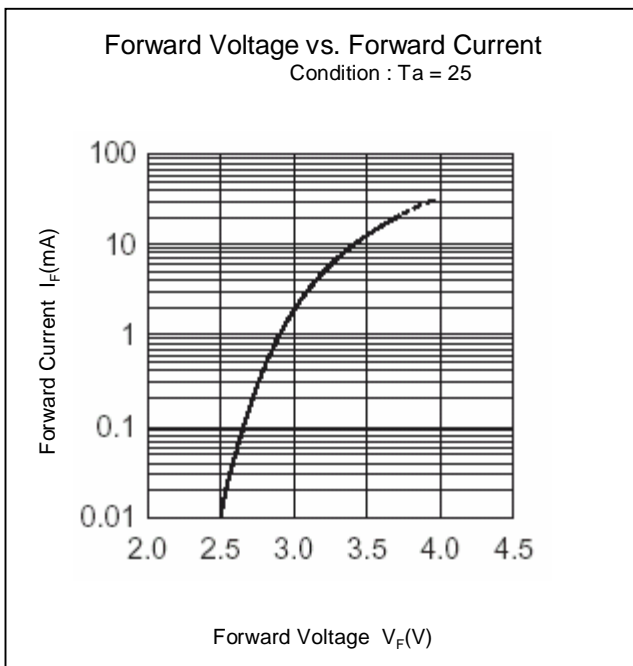
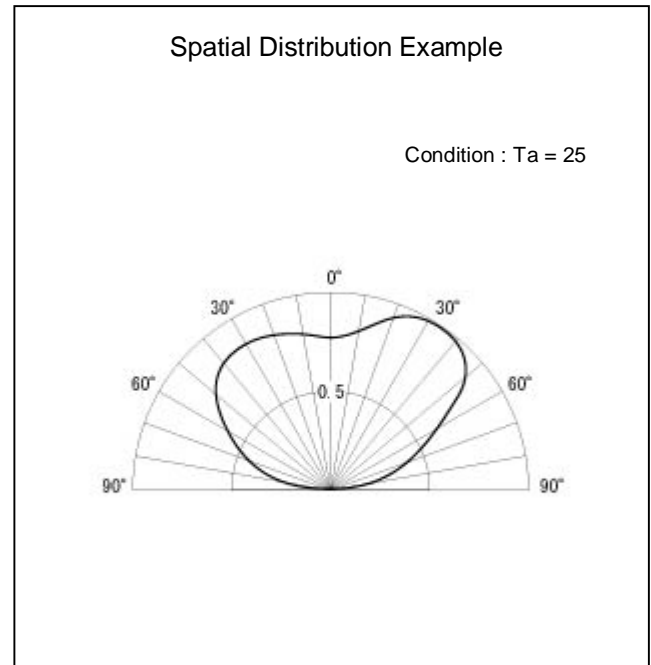
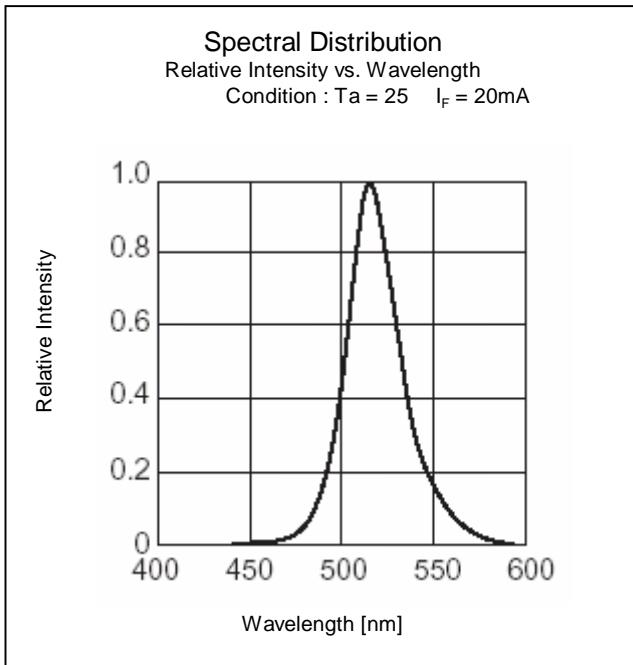

Technical Data (UY)

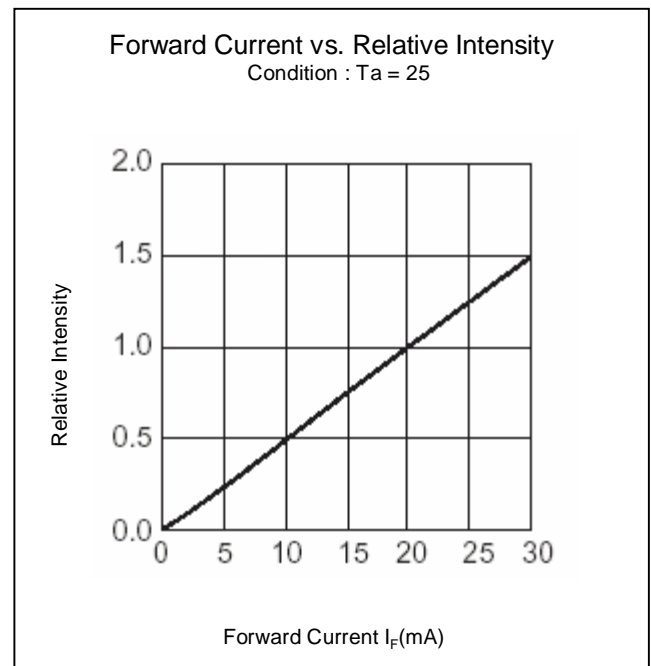
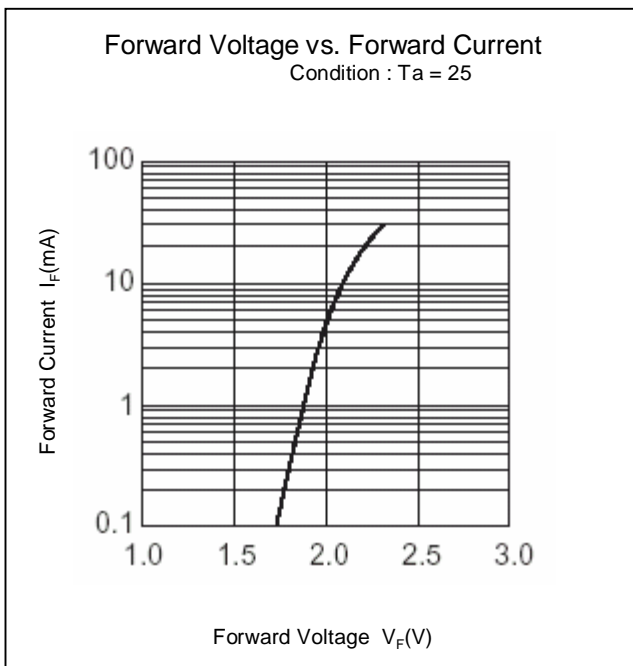
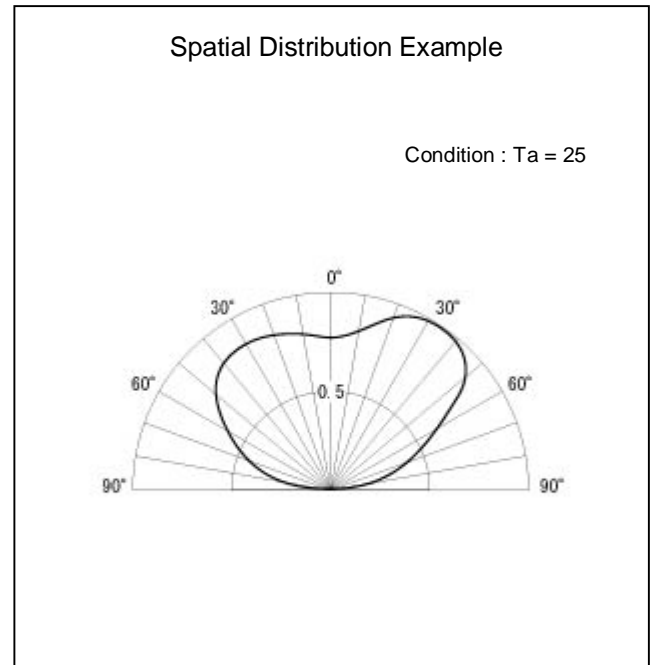
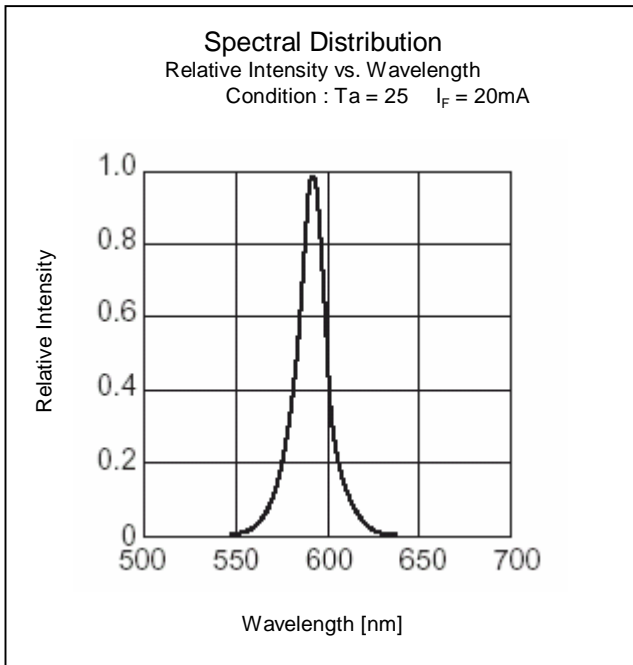

Technical Data (UR)

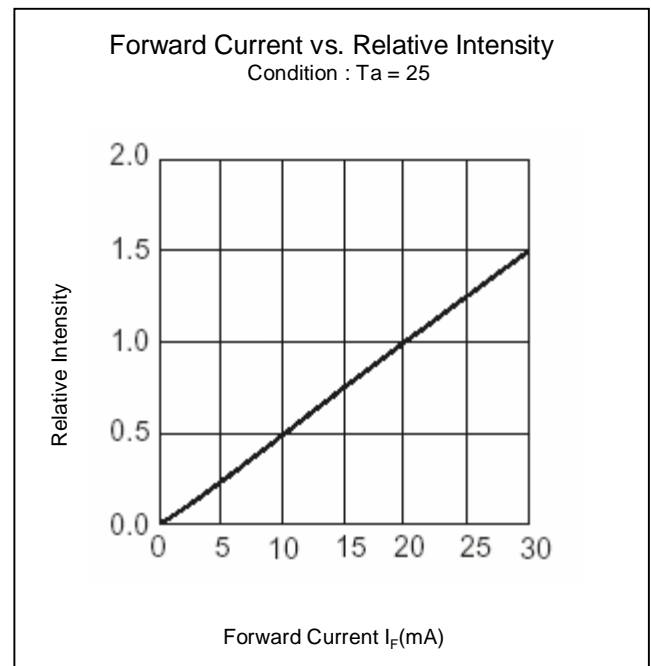
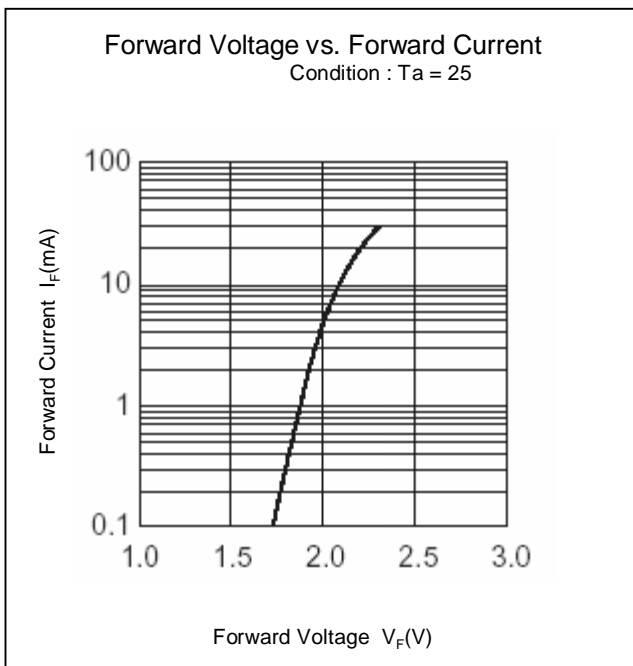
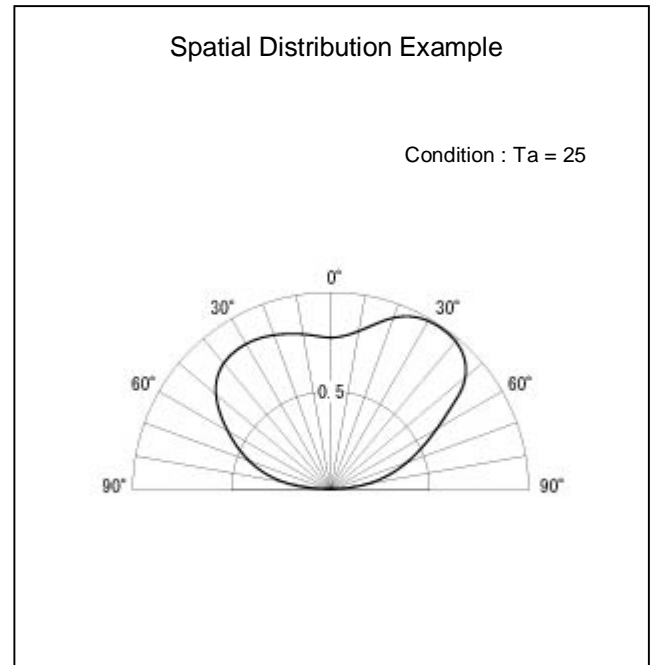
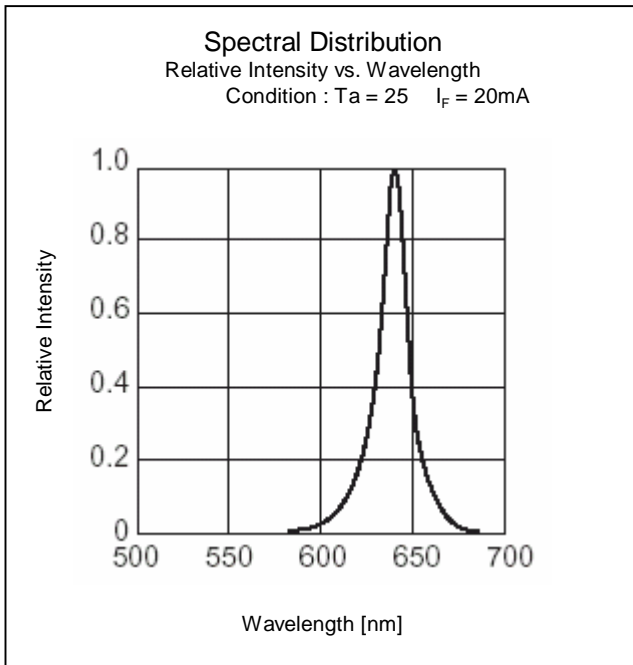

Package Dimensions

(Unit: mm)

Weight: (1.40)mg

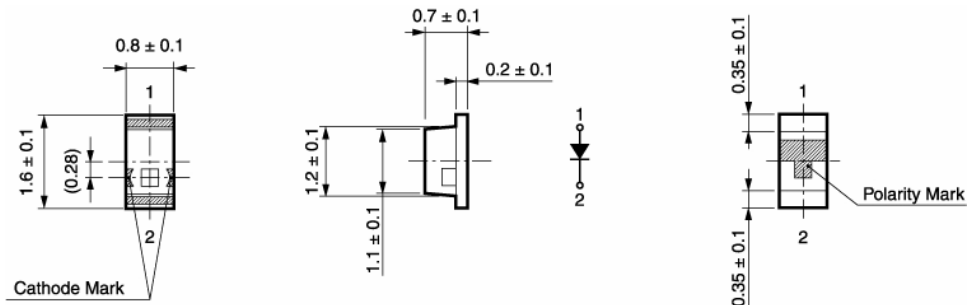

Recommended Soldering Pattern

(Unit: mm)

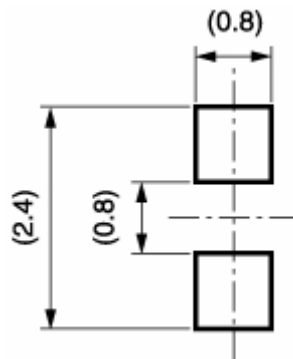

Taping Specification

(Unit: mm)

Quantity : 4,000pcs/ reel (standard)

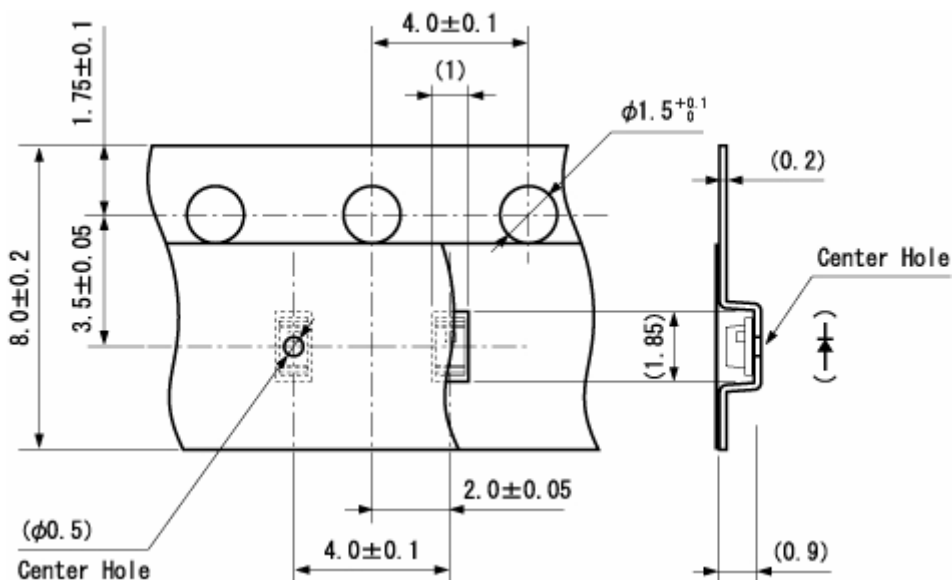

Reflow Soldering Conditions

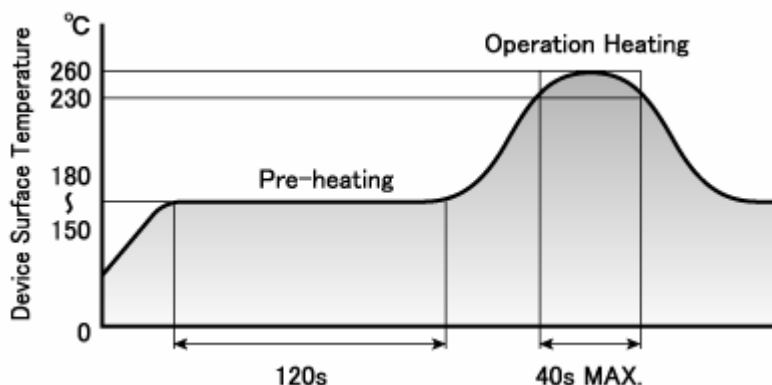

- 1) The above profile temperature gives the maximum temperature of the LED resin surface. Please set the temperature so as to avoid exceeding this range.
- 2) Total times of reflow soldering process shall be no more than 2 times. When the second reflow soldering process is performed, intervals between the first and second reflow should be short as possible (while allowing some time for the component to return to normal temperature after the first reflow) in order to prevent the LED from absorbing moisture.
- 3) Temperature fluctuation to the LED during the pre-heating process shall be minimized. (6 maximum)

Manual Soldering Conditions

Iron tip temp.	350	(MAX.)
Soldering time and frequency	3 s	(MAX.)
	1 time	(MAX.)

Reliability Testing Result

Reliability Testing Result	Applicable Standard	Testing Conditions	Duration	Failure
Room Temp. Operating Life	EAJED-4701/100(101)	Ta = 25 , If = Maximum Rated Current	1,000 h	0/25
Resistance to Soldering Heat	EAJED-4701/300(301)	Pre-heating : 150 ~ 180 120s Max. Operation Heating : 230 40s Max. Peak Temperature : 260	Twice	0/25
Temperature Cycling	EAJED-4701/100(105)	Minimum Rated Storage Temperature(30min) ~ Normal Temperature(15min) ~ Maximum Rated Storage Temperature(30min) ~ Normal Temperature(15min)	5 cycles	0/25
Wet High Temp. Storage Life	EAJED-4701/100(103)	Ta = 60 ± 2 , RH = 90 ± 5%	1,000 h	0/25
High Temp. Storage Life	EAJED-4701/200(201)	Ta = Maximum Rated Storage Temperature	1,000 h	0/25
Low Temp. Storage Life	EAJED-4701/200(202)	Ta = Minimum Rated Storage Temperature	1,000 h	0/25
Vibration, Variable Frequency	EAJED-4701/400(403)	98.1m/s ² (10G), 100 ~ 2KHz sweep for 20min., XYZ each direction	2 h	0/10

Failure Criteria

Items	Symbols	Conditions	Failure criteria
Luminous Intensity	Iv	If Value of each product Luminous Intensity	Testing Min. Value < Spec. Min. Value x 0.5
Forward Voltage	V _F	If Value of each product Forward Voltage	Testing Max. Value Spec. Max. Value x 1.2
Reverse Current	I _R	V _R = Maximum Rated Reverse Voltage V	Testing Max. Value Spec. Max. Value x 2.5
Cosmetic Appearance	-	-	Occurrence of notable decoloration, deformation and cracking

Special Notice to Customers Using the Products and Technical Information Shown in This Data Sheet

- 1) The technical information shown in the data sheets are limited to the typical characteristics and circuit examples of the referenced products. It does not constitute the warranting of industrial property nor the granting of any license.
- 2) For the purpose of product improvement, the specifications, characteristics and technical data described in the data sheets are subject to change without prior notice. Therefore it is recommended that the most updated specifications be used in your design.
- 3) When using the products described in the data sheets, please adhere to the maximum ratings for operating voltage, heat dissipation characteristics, and other precautions for use. We are not responsible for any damage which may occur if these specifications are exceeded.
- 4) The products that have been described to this catalog are manufactured so that they will be used for the electrical instrument of the benchmark (OA equipment, telecommunications equipment, AV machine, home appliance and measuring instrument).
The application of aircrafts, space borne application, transportation equipment, medical equipment and nuclear power control equipment, etc. needs a high reliability and safety, and the breakdown and the operation might influence the life or the human body. Please consult us beforehand if you plan to use our product for the usages of aircrafts, space borne application, transportation equipment, medical equipment and nuclear power control equipment, etc. except OA equipment, telecommunications equipment, AV machine, home appliance and measuring instrument.
- 5) In order to export the products or technologies described in this data sheet which are under the "Foreign Exchange and Foreign Trade Control Law," it is necessary to first obtain an export permit from the Japanese government.
- 6) No part of this data sheet may be reprinted or reproduced without prior written permission from Stanley Electric Co., Ltd.
- 7) The most updated edition of this data sheet can be obtained from the address below:
<http://www.stanley-components.com>