

シリコンPNPエピタキシャルプレーナ型トランジスタ(2SD2083とコンプリメンタリ)

用途：チョッパレギュレータ、DCモータ駆動、一般用

絶対最大定格 (Ta=25)

記号	規格値	単位
V _{CB0}	- 120	V
V _{CEO}	- 120	V
V _{EBO}	- 6	V
I _C	- 25(パルス - 40)	A
I _B	- 2	A
P _C	120(T _C =25)	W
T _J	150	
T _{stg}	- 55 ~ + 150	

電気的特性 (Ta=25)

記号	試験条件	規格値	単位
I _{CB0}	V _{CB} = - 120V	- 10max	μA
I _{EBO}	V _{EB} = - 6V	- 10max	mA
V _{(BR)CEO}	I _C = - 25mA	- 120min	V
h _{FE}	V _{CE} = - 4V, I _C = - 12A	2000min	
V _{CE(sat)}	I _C = - 12A, I _B = - 24mA	- 1.8max	V
V _{BE(sat)}	I _C = - 12A, I _B = - 24mA	- 2.5max	V
f _T	V _{CE} = - 12V, I _E = 1A	50typ	MHz
C _{OB}	V _{CB} = - 10V, f = 1MHz	230typ	pF

外形図 MT-100(TO3P)

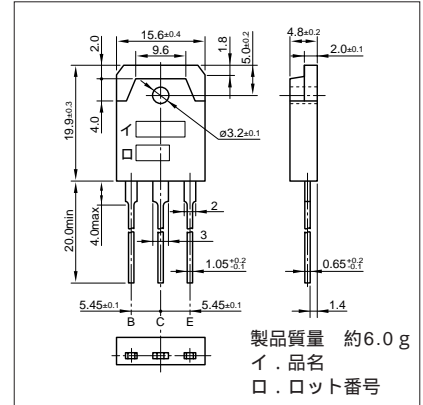

代表的スイッチング特性 (エミッタ接地)

V _{CC} (V)	R _L (Ω)	I _C (A)	V _{BB1} (V)	V _{BB2} (V)	I _{B1} (mA)	I _{B2} (mA)	t _{on} (μs)	t _{stg} (μs)	t _f (μs)
-24	2	-12	-10	5	-24	24	1.0typ	3.0typ	1.0typ

I_C-V_{CE}特性 (代表例)

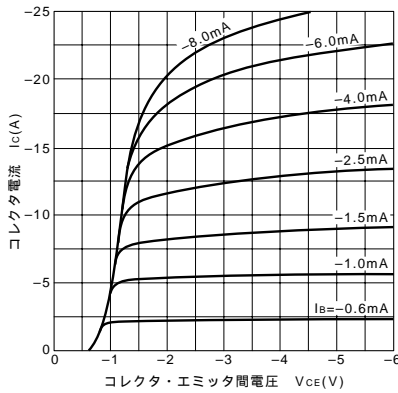

V_{CE(sat)}-I_B特性 (代表例)

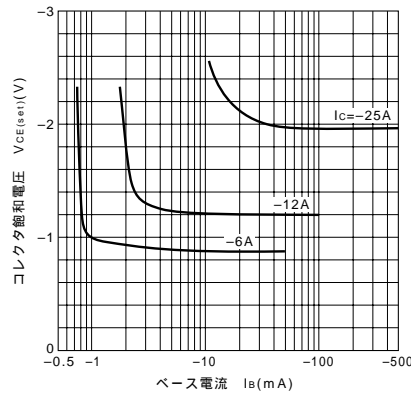

I_C-V_{BE}温度特性 (代表例)

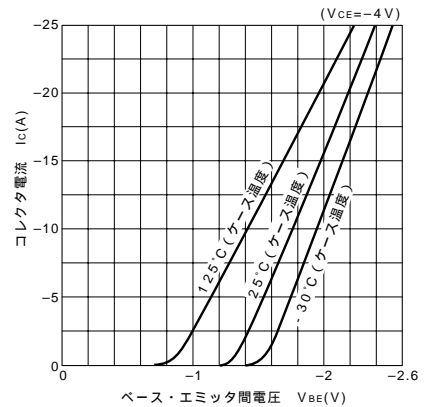

h_{FE}-I_C特性 (代表例)

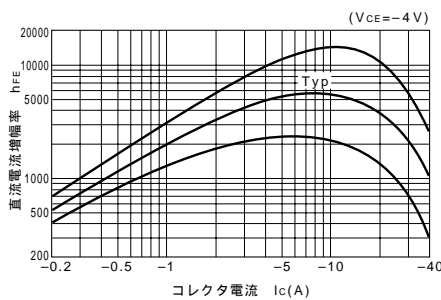

h_{FE}-I_C温度特性 (代表例)

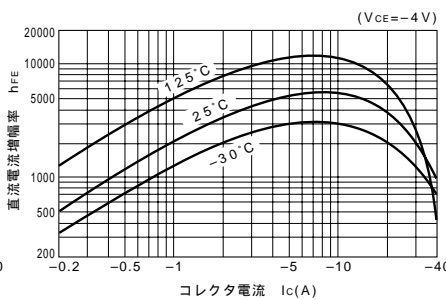

θ_{j-a}-t特性

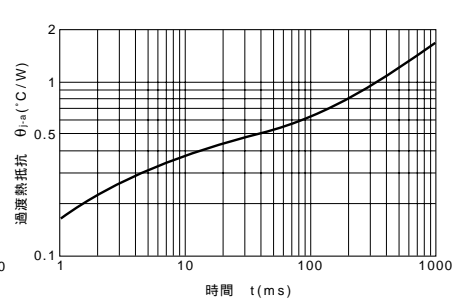

f_T-I_E特性 (代表例)

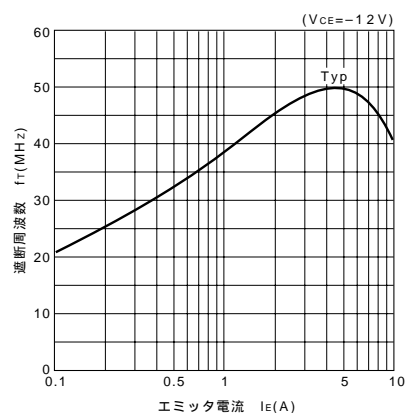

ASO曲線 (単発パルス)

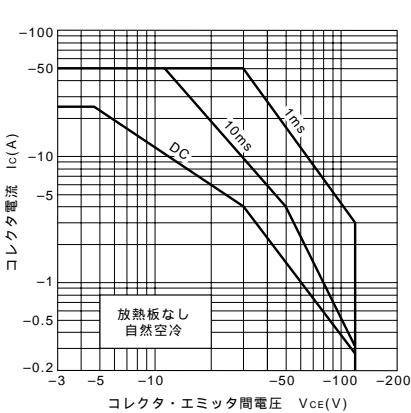

P_C-T_a定格

