

# Airpax Series 6700 Thermostat

The Airpax Series 6700 is a miniature bimetallic snap acting thermostat which provides accurate and reliable sensing and switching in a single device. Primarily developed for thermal management applications on power supplies, the Series 6700 is also ideally suited for use on crowded P.C. boards. It provides fast, positive response and excellent repeatability with 1 amp switching capability at 48 VDC over its operating temperature range of 40°C to 130°C (104°F to 266°F). The operating temperature is pre-set at the factory and is non-adjustable in the field.

The single pole/single throw switch assembly features a bimetallic element that is rated 100,000 cycles at 5 VDC 20mA resistive load. This unit features a positive snap action, available in either normally closed, open on rising temperature or normally open, close on rising temperature.

The 6700 Thermostat dimensionally conforms to the international product package standard Y220/T0220. Thus, the 6700 may be automatically placed and soldered onto P.C. boards with high speed automated equipment, eliminating the need for the expensive hand placement and termination required today for most power supply thermostats.

The nickel-plated copper mounting bracket allows this device to be directly mounted to the heat sink to sense an over-temperature condition caused by other components mounted close by or insufficient cooling due to external conditions.

A plastic mounting bracket is utilized when VDE approval is required.

Typical uses include turning on an indicator light, sounding an audible alarm, switching on a control circuit to send a message to a display screen or even switching a circuit to shut down a system. Applications include computers and computer peripherals, aircraft, automotive, and test equipment.

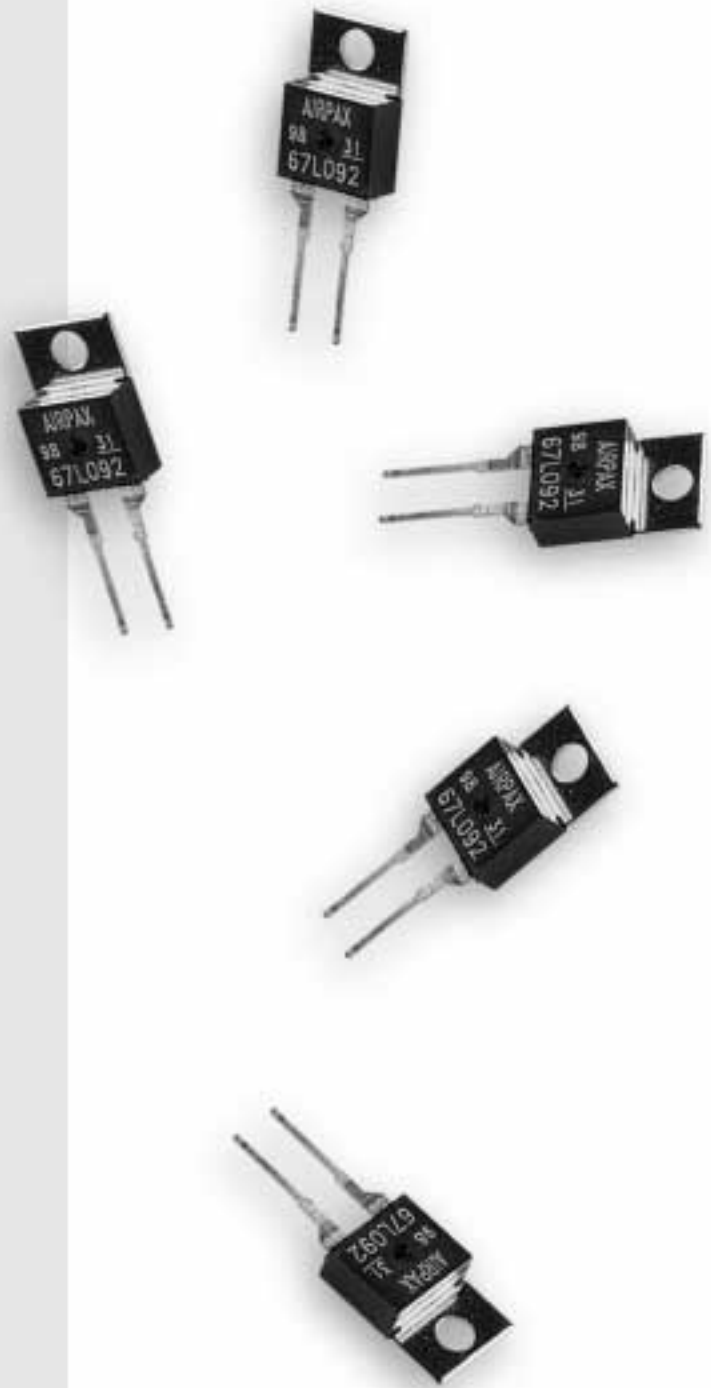

# AIRPAX®

©Copyright 1999 Airpax · All Rights Reserved · 00070 7/99

## SPECIFICATIONS

- **Contact Resistance:**  
50 Milliohms max. (before and after rated life)
- **Contact Ratings:**

Cycles	Voltage	Amps (resistive)
30,000	48 VDC	1
30,000	120 VAC	1
100,000	5 VDC	.020
100,000	5 VDC	.001
- **Contact Operations:** Either open on rise or close on rise
- **Operating Temperature Range:**  
40°C (104°F) to 130°C (266°F)
- **Standard Operating Temperature Tolerance:**  
±5°C (±9°F) Nominal operating temperature settings  
in 5°C (9°F) increments
- **US Patent No:** 4,795,997
- **Short Term Exposure Limit:** 260°C (500°F), 10 sec.
- **Long Term Exposure Limit:** -55°C (-67°F) to 160°C (320°F)
- **Dielectric Strength:** 1480 VAC 60Hz, 1 second  
terminals to case for nickel-plated copper bracket. 2000  
VAC 60Hz, 1 second terminals to case for plastic bracket.
- **Insulation Resistance:** 100 Megohms at 500 VDC
- **Contact Bounce - make:** 3 ms max.
- **Weight:** Approximately 0.5 grams

- **Seal:** Epoxy sealed for wave soldering and cleaning.  
Moisture proof per Airpax Spec. S-722 (unit will not leak while  
submerged in 9" of water for a minimum of two minutes).
- **Vibration:** Per Mil-Std-202, Method 204D,  
Test Condition D, 10-2,000 Hz.
- **Shock:** Per Mil-Std-202, Method 213, Test Condition C,  
100 G's, 6 milliseconds, ½ sine wave.
- **Chemical Resistance:** Unit is resistant to water, salt, alcohol,  
ammonia, trichlorethane, and most other organic solvents.
- **Solderability:** Terminal material is selectively striped  
with 60/40 solder for improved solderability.
- **Resistance to Soldering Heat:**  
Per Mil-Std-202F, Method 210A, Test Condition E.
- **File Numbers:**  
UL Recognized E36687  
CSA Certified LR25561  
VDE Approval I 1624, 2-4510-1004 (plastic bracket only)

## MATERIALS

- **Seal:** High temperature epoxy
- **Base:** PPS (Polyphenylene Sulfide), 94 VO rated
- **Terminals:** 65% Copper, 18% Nickel
- **Contacts:** Gold-plated or overlay, Silver cross bar
- **Bracket:** Nickel-plated copper or high pressure  
laminated plastic

## Airpax 6700 Series Thermostats

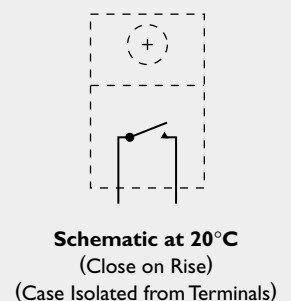
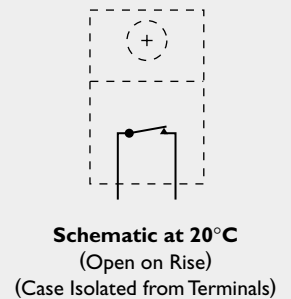
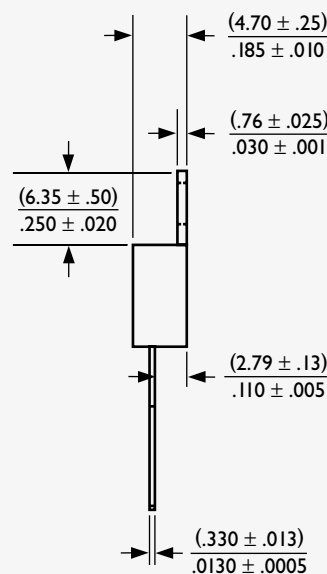
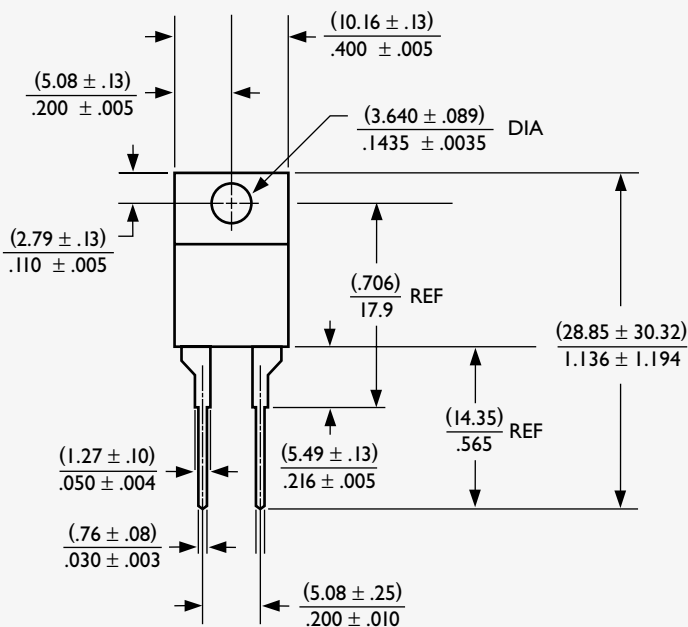

## 6700 SERIES STANDARD TEMPERATURE CALIBRATIONS

OPERATE ( $\pm 5^{\circ}\text{C}$ )	RESET (MIN $^{\circ}\text{C}$ )	DIFFERENTIAL (MIN $^{\circ}\text{C}$ )
40	20	4
45	20	4
50	30	4
55	30	4
60	40	4
65	40	4
70	50	4
75	50	4
80	55	6
85	55	6
90	60	6
95	60	6
100	70	6
105	70	6
110	80	6
115	80	6
120	85	9
125	85	9
130	90	9

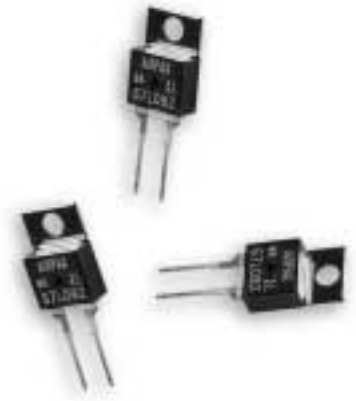

### HOW TO USE THIS CHART

Each thermostat Part Number consists of functional "building blocks" to enable the user to specify clearly and precisely the desired characteristics in each category. Select the proper Code in each category, then transfer it to the box indicated. Unless a special requirement is indicated, the Part Number will be complete when the proper temperature is selected. If you have a special requirement, please call Airpax for a factory assigned number to complete the Part Number.

**Example:** A 67F060 thermostat will close (make contact) on a rising temperature from  $55^{\circ}\text{C}$  to  $65^{\circ}\text{C}$  and will reset (break contact) on a falling temperature no less than  $4^{\circ}\text{C}$  lower than the actual close temperature and no lower than  $40^{\circ}\text{C}$  actual temperature.

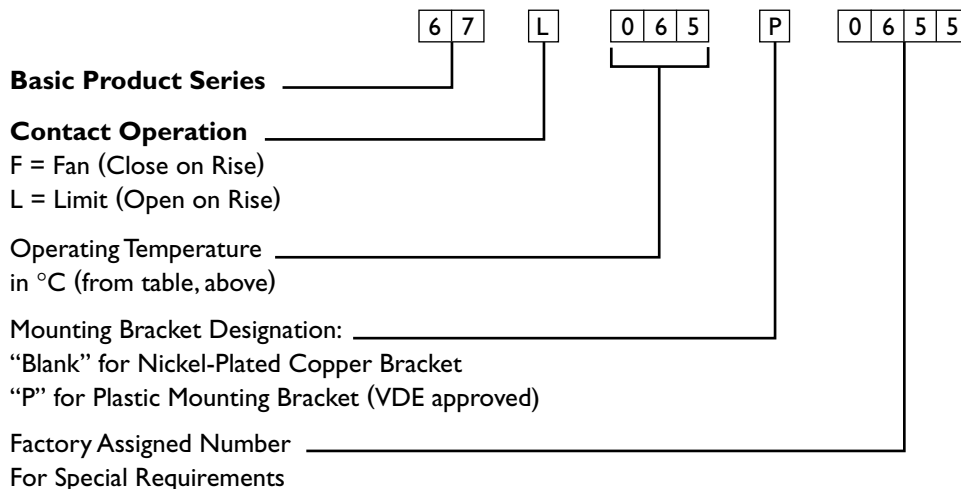

The mounting bracket designation and the 4 digit manufacturing number are used for ordering special features and may not appear as part of the marking on the thermostat.

Temperature set point calibration is checked at Airpax with precision test equipment and proven methods. Because customer checking methods may differ, a typical variance allowed for correlation is  $\pm 1^{\circ}\text{C}$ .

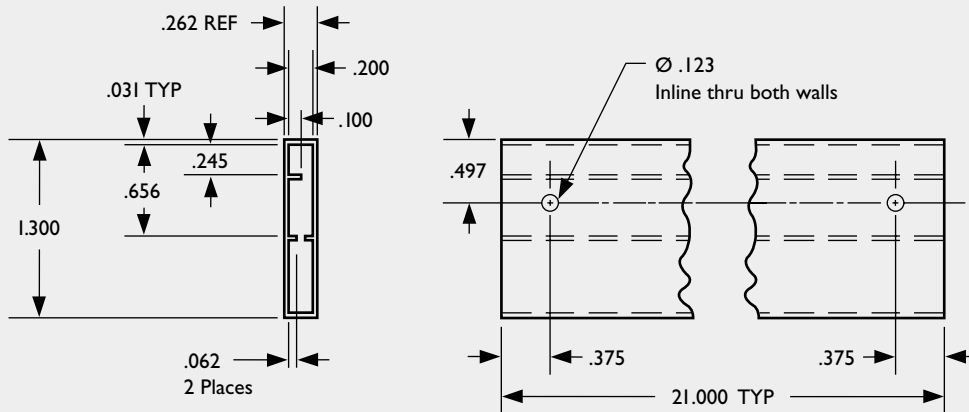

**Packaging:** (standard)

All samples and production orders will be shipped in plastic, industry standard shipping tubes.

*This information is subject to change without notice.*

**AIRPAX<sup>®</sup>**

©Copyright 1999 Airpax · All Rights Reserved · 00070 7/99

Thermal Sensing Products, Inc.

807 Woods Road · P.O. Box 520 · Cambridge, MD 21613-0520 · USA

Phone: 410.228.4600 · Fax: 410.228.8910 · [www.airpax.net](http://www.airpax.net)