

Hyper Multi TOPLED® Enhanced optical Power LED (HOP2000 / ATON®)

LATB T66B



Vorläufige Daten / Preliminary Data

Besondere Merkmale

- **Gehäusetyyp:** weißes P-LCC-4 Gehäuse; Kontrasterhöhung durch schwarze Oberfläche (RGB-Displays) und diffuses Harz
- **Besonderheit des Bauteils:** additive Farbmischung durch unabhängige Ansteuerung aller Chips
- **Wellenlänge:** 617 nm (amber), 528 nm (true green), 470 nm (blau)
- **Abstrahlwinkel:** Lambertischer Strahler (120°)
- **Technologie:** InGaAIP (amber), InGaN (true green, blau)
- **optischer Wirkungsgrad:** 24 lm/W (amber), 13 lm/W (true green), 3 lm/W (blau)
- **Gruppierungsparameter:** Lichtstärke
- **Verarbeitungsmethode:** für alle SMT-Bestücktechniken geeignet
- **Lötmethode:** IR Reflow Löten und Wellenlöten (TTW)
- **Vorbehandlung:** nach JEDEC Level 2
- **Gurtung:** 8 mm Gurt mit 2000/Rolle, ø180 mm oder 8000/Rolle, ø330 mm
- **ESD-Festigkeit:** ESD-sicher bis 2 kV nach EOS/ESD-5.1-1993

Anwendungen

- Anzeigen im Innen- und Außenbereich (z.B. im Verkehrsbereich; Laufschriftanzeigen)
- Leuchtdiodenchips getrennt ansteuerbar
- Vollfarbdisplays bzw. RGB-Displays
- Hinterleuchtung (LCD, Schalter, Tasten, Displays, Werbebeleuchtung, Allgemeinbeleuchtung)
- Einkopplung in Lichtleiter

Features

- **package:** white P-LCC-4 package; higher contrast by a black surface (RGB-Displays) and diffused resin
- **feature of the device:** additive mixture of color stimuli by independent driving of each chip
- **wavelength:** 617 nm (amber), 528 nm (true green), 470 nm (blue)
- **viewing angle:** Lambertian Emitter (120°)
- **technology:** InGaAIP (amber), InGaN (true green, blue)
- **optical efficiency:** 24 lm/W (amber), 13 lm/W (true green), 3 lm/W (blue)
- **grouping parameter:** luminous intensity
- **assembly methods:** suitable for all SMT assembly methods
- **soldering methods:** IR reflow soldering and TTW soldering
- **preconditioning:** acc. to JEDEC Level 2
- **taping:** 8 mm tape with 2000/reel, ø180 mm or 8000/reel, ø330 mm
- **ESD-withstand voltage:** up to 2 kV acc. to EOS/ESD-5.1-1993

Applications

- indoor and outdoor displays (e.g. displays for traffic; light writing displays)
- LED chips can be controlled separately
- full color displays, RGB-Displays
- backlighting (LCD, switches, keys, displays, illuminated advertising, general lighting)
- coupling into light guides

Typ Type	Emissions- farbe Color of Emission	Farbe der Lichtaustritts- fläche Color of the Light Emitting Area	Lichtstärke Luminous Intensity $I_F = 20 \text{ mA}$ $I_V \text{ (mcd)}$		
			amber	true green	blue
LATB T66B	amber true green blue	colorless diffused and black painted package surface	180 ... 450	180 ... 450	45 ... 112

Bestell - Information
Ordering Information

Typ Type	Bestellnummer Ordering Code
LATB T66B-ST-1+ST-78+PQ-1	Q65110-A0152
LATB T66B-ST-1+ST-7+PQ-1	Q65110-A0181
LATB T66B-ST-1+ST-8+PQ-1	Q65110-A0182

Anm.: -78 gesamter Farbbereich, Lieferung in Einzelgruppen (siehe **Seite 5**)

Die Standardlieferform von Serientypen beinhaltet eine Familiengruppe. Einzelne Gruppen sind nicht erhältlich.

In einer Verpackungseinheit / Gurt ist immer nur eine Gruppe pro Farbe enthalten.

Dimmverhältnis im Gleichstrom-Betrieb max. 5:1 für amber

Note: -78 Total color tolerance range, delivery in single groups (please see **page 5**)

The standard shipping format for serial types includes a family group. Individual groups are not available.

No packing unit / tape ever contains more than one luminous intensity group per color.

Dimming range for direct current mode max. 5:1 for amber

Grenzwerte
Maximum Ratings

Bezeichnung Parameter	Symbol Symbol	Werte Values			Einheit Unit
		LA	LT	LB	
Betriebstemperatur Operating temperature range	T_{op}	- 40 ... + 100			°C
Lagertemperatur Storage temperature range	T_{stg}	- 40 ... + 100			°C
Sperrschichttemperatur Junction temperature	T_j	+ 125	+ 125	+ 110	°C
Durchlassstrom Forward current	I_F	70	30	30	mA
Stoßstrom Surge current $t_p = 10 \mu s, D = 0.005$	I_{FM}	0.10	0.25	0.20	A
Sperrspannung Reverse voltage	V_R	5	5	5	V
Leistungsaufnahme Power consumption	P_{tot}	180	140	140	mW
Wärmewiderstand Thermal resistance					
Sperrschicht/Umgebung Junction/ambient	1 chip on $R_{th JA}$	480	530	530	K/W
	3 chips on $R_{th JA}$	770	820	820	K/W
Sperrschicht/Löt看pad Junction/solder point	1 chip on $R_{th JS}$	260	310	310	K/W
	3 chips on $R_{th JS}$	420	470	470	K/W
Montage auf PC-Board FR 4 (Padgröße $\geq 16 \text{ mm}^2$) mounted on PC board FR 4 (pad size $\geq 16 \text{ mm}^2$)					

Kennwerte ($T_A = 25\text{ °C}$)

Characteristics

Bezeichnung Parameter	Symbol Symbol	Werte Values			Einheit Unit
		LA	LT	LB	
Wellenlänge des emittierten Lichtes (typ.) Wavelength at peak emission $I_F = 20\text{ mA}$	λ_{peak}	628	523	465	nm
Dominantwellenlänge ¹⁾ (typ.) Dominant wavelength $I_F = 20\text{ mA}$	λ_{dom}	617 -2 / +7	528 ± 9	470 ± 6	nm
Spektrale Bandbreite bei 50 % $I_{\text{rel max}}$ (typ.) Spectral bandwidth at 50 % $I_{\text{rel max}}$ $I_F = 20\text{ mA}$	$\Delta\lambda$	16	33	25	nm
Abstrahlwinkel bei 50 % I_V (Vollwinkel) (typ.) Viewing angle at 50 % I_V	2ϕ	120	120	120	Grad deg.
Durchlassspannung ²⁾ (min.) Forward voltage (typ.) $I_F = 20\text{ mA}$ (max.)	V_F V_F V_F	2.0 2.4	3.5 4.3	3.8 4.3	V V V
Sperrstrom (typ.) Reverse current (max.) $V_R = 5\text{ V}$	I_R I_R	0.01 10	0.01 10	0.01 10	μA μA
Temperaturkoeffizient von λ_{peak} (typ.) Temperature coefficient of λ_{peak} $I_F = 20\text{ mA}; -10\text{ °C} \leq T \leq 100\text{ °C}$	$TC_{\lambda_{\text{peak}}}$	0.13	0.04	0.05	nm/K
Temperaturkoeffizient von λ_{dom} (typ.) Temperature coefficient of λ_{dom} $I_F = 20\text{ mA}; -10\text{ °C} \leq T \leq 100\text{ °C}$	$TC_{\lambda_{\text{dom}}}$	0.06	0.03	0.04	nm/K
Temperaturkoeffizient von V_F (typ.) Temperature coefficient of V_F $I_F = 20\text{ mA}; -10\text{ °C} \leq T \leq 100\text{ °C}$	TC_V	- 1.8	- 3.6	- 3.1	mV/K
Optischer Wirkungsgrad (typ.) Optical efficiency $I_F = 20\text{ mA}$	η_{opt}	24	13	3	lm/W

¹⁾ Wellenlängen werden mit einer Stromeinprägungsdauer von 25 ms und einer Genauigkeit von $\pm 1\text{ nm}$ ermittelt.
Wavelengths are tested at a current pulse duration of 25 ms and a tolerance of $\pm 1\text{ nm}$.

²⁾ Spannungswerte werden mit einer Stromeinprägungsdauer von 1 ms und einer Genauigkeit von $\pm 0,1\text{ V}$ ermittelt.
Voltages are tested at a current pulse duration of 1 ms and a tolerance of $\pm 0.1\text{ V}$.

1) Wellenlängengruppen / Wavelength groups

Gruppe Group	true green		Einheit Unit
	min.	max.	
7	519	528	nm
8	528	537	nm

Lichtgruppe Luminous Intensity Group	Lichtstärke Luminous Intensity	Lichtstrom Luminous Flux	Lichtstärke Luminous Intensity	Lichtstrom Luminous Flux	Lichtstärke Luminous Intensity	Lichtstrom Luminous Flux
	I_V (mcd)	Φ_V (mlm)	I_V (mcd)	Φ_V (mlm)	I_V (mcd)	Φ_V (mlm)
	amber		true green		blue	
S+S+P	180 ... 280	680 (typ.)	180 ... 280	680 (typ.)	45 ... 71	95 (typ.)
S+S+Q	180 ... 280	680 (typ.)	180 ... 280	680 (typ.)	71 ... 112	270 (typ.)
S+T+P	180 ... 280	680 (typ.)	280 ... 450	1075 (typ.)	45 ... 71	95 (typ.)
S+T+Q	180 ... 280	680 (typ.)	280 ... 450	1075 (typ.)	71 ... 112	270 (typ.)
T+S+P	280 ... 450	1075 (typ.)	180 ... 280	680 (typ.)	45 ... 71	95 (typ.)
T+S+Q	280 ... 450	1075 (typ.)	180 ... 280	680 (typ.)	71 ... 112	270 (typ.)
T+T+P	280 ... 450	1075 (typ.)	280 ... 450	1075 (typ.)	45 ... 71	95 (typ.)
T+T+Q	280 ... 450	1075 (typ.)	280 ... 450	1075 (typ.)	71 ... 112	270 (typ.)

Helligkeitswerte werden mit einer Stromeinprägedauer von 25 ms und einer Genauigkeit von ± 11 % ermittelt.
Luminous intensity is tested at a current pulse duration of 25 ms and a tolerance of ± 11 %.

Gruppenbezeichnung auf Etikett

Group Name on Label

Beispiel: T-1+S-7+P-1

Example: T-1+S-7+P-1

Lichtgruppe	Wellenlänge (keine Gruppierung)	Lichtgruppe	Wellenlänge	Lichtgruppe	Wellenlänge (keine Gruppierung)
Luminous Intensity Group (amber)	Wavelength (no grouping) (amber)	Luminous Intensity Group (true green)	Wavelength (true green)	Luminous Intensity Group (blue)	Wavelength (no grouping) (blue)
T	1	S	7	P	1

Relative spektrale Emission $I_{rel} = f(\lambda)$, $T_A = 25\text{ °C}$, $I_F = 20\text{ mA}$

Relative Spectral Emission

$V(\lambda)$ = spektrale Augenempfindlichkeit

Standard eye response curve

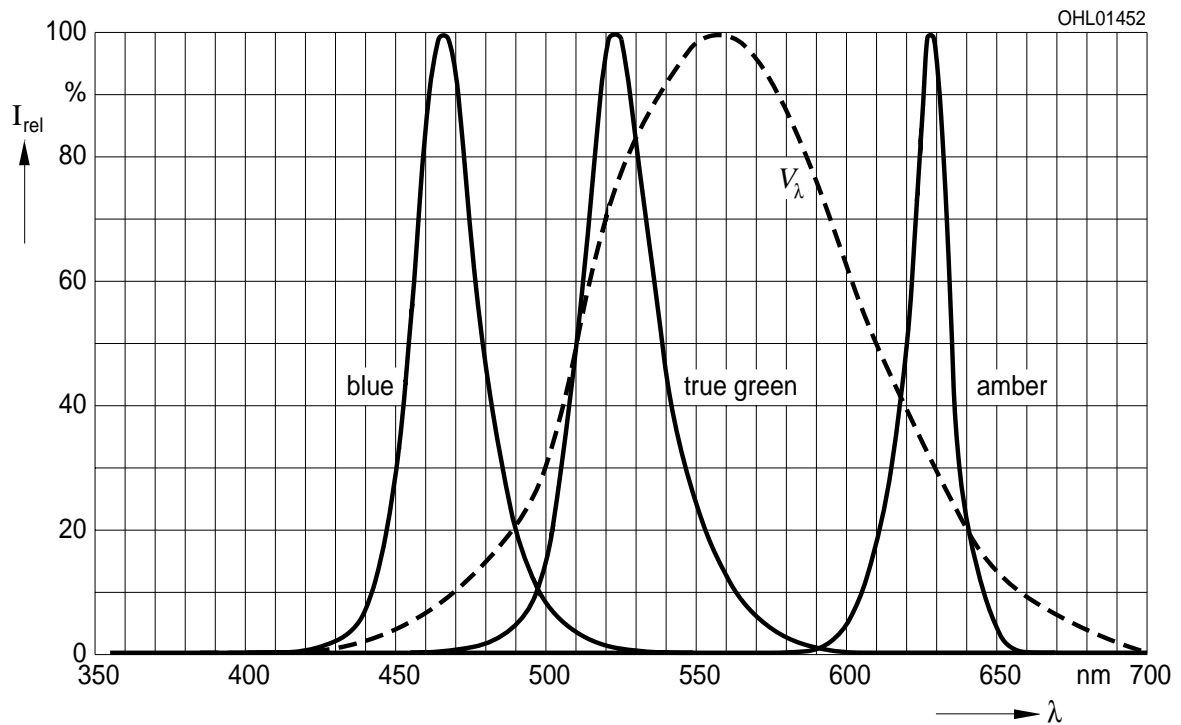

Abstrahlcharakteristik $I_{rel} = f(\varphi)$

Radiation Characteristic

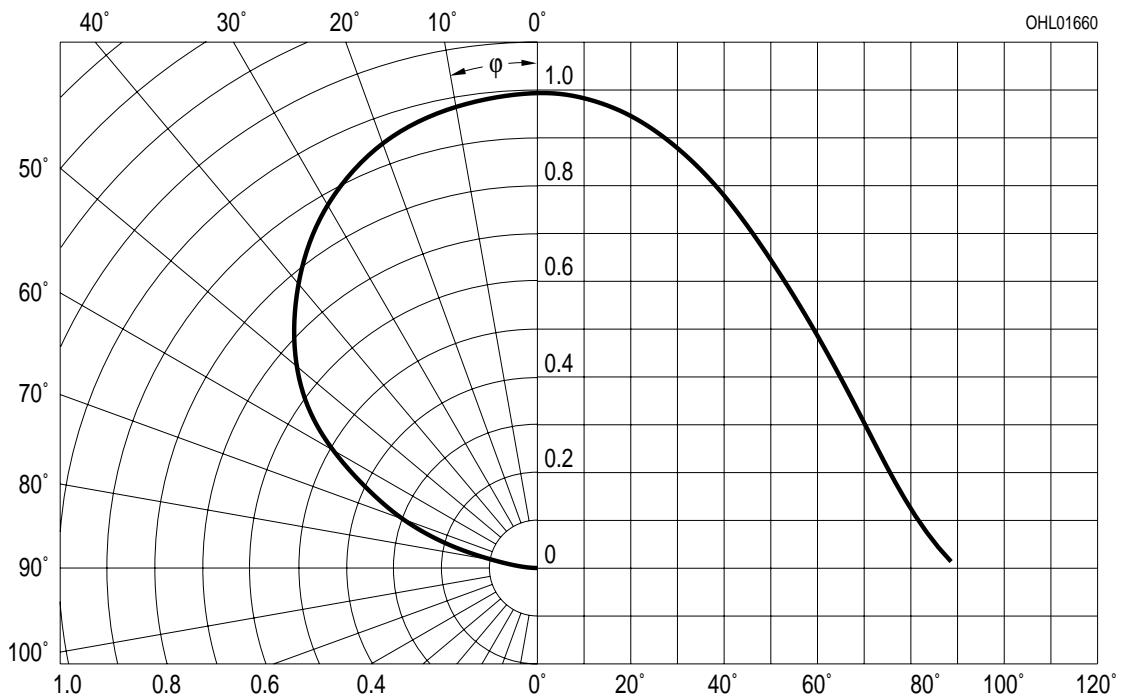

Durchlassstrom $I_F = f(V_F)$

Forward Current

$T_A = 25\text{ }^\circ\text{C}$

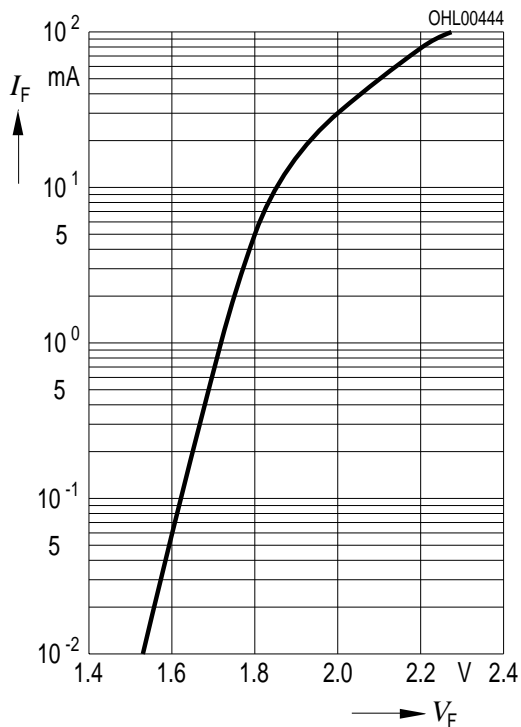

Relative Lichtstärke $I_V/I_{V(20\text{ mA})} = f(I_F)$

Relative Luminous Intensity

$T_A = 25\text{ }^\circ\text{C}$

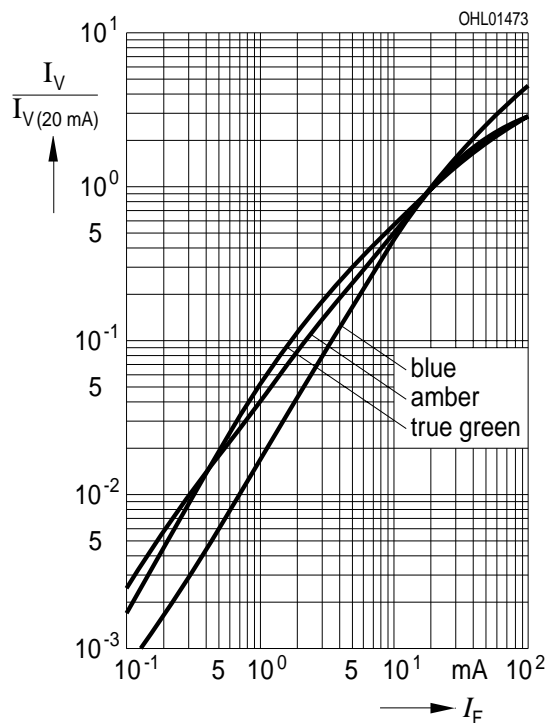

Durchlassstrom $I_F = f(V_F)$

Forward Current

$T_A = 25\text{ }^\circ\text{C}$

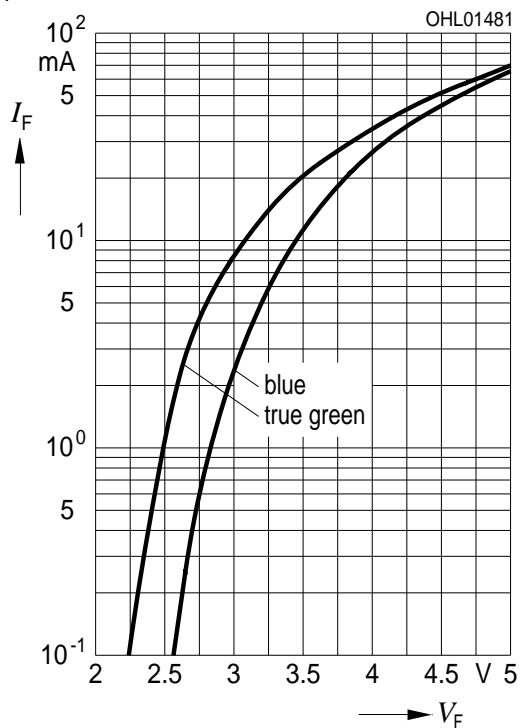

Relative Lichtstärke $I_V/I_{V(25\text{ }^\circ\text{C})} = f(T_A)$

Relative Luminous Intensity

$I_F = 20\text{ mA}$

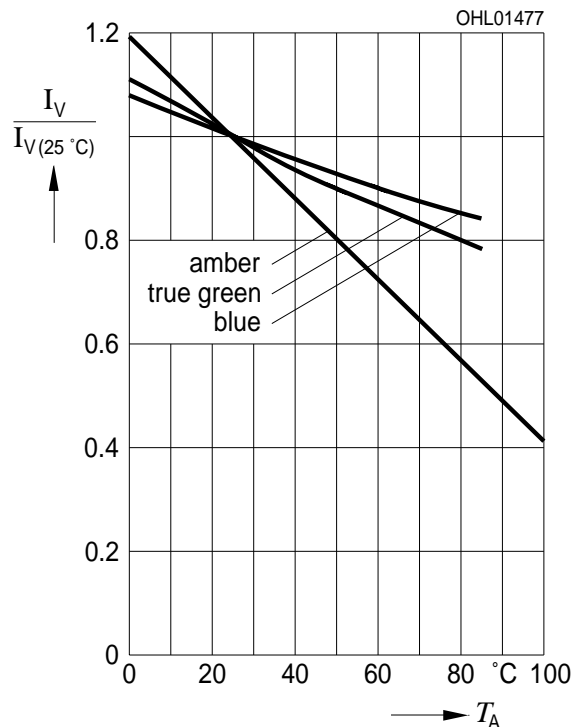

Maximal zulässiger Durchlassstrom $I_F = f(T)$
Max. Permissible Forward Current

1 chip on

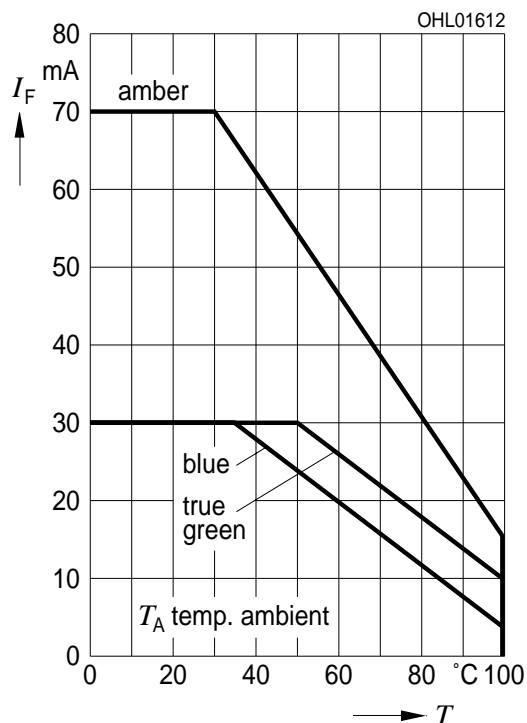

Maximal zulässiger Durchlassstrom $I_F = f(T)$
Max. Permissible Forward Current

3 chips on

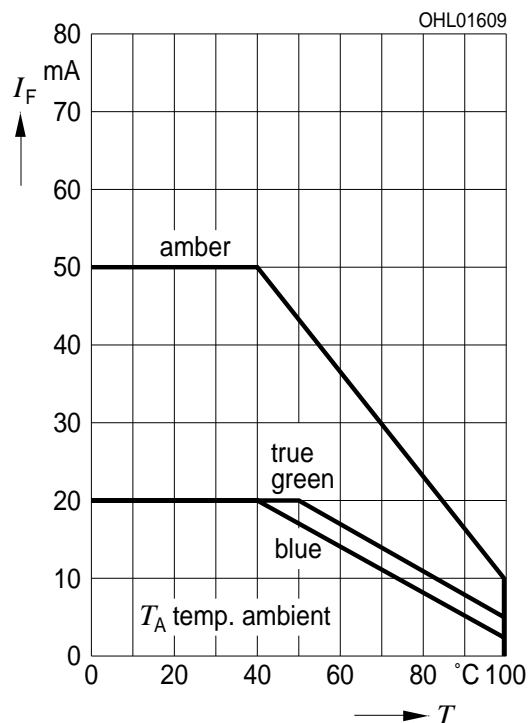

Maximal zulässiger Durchlassstrom $I_F = f(T)$
Max. Permissible Forward Current

1 chip on

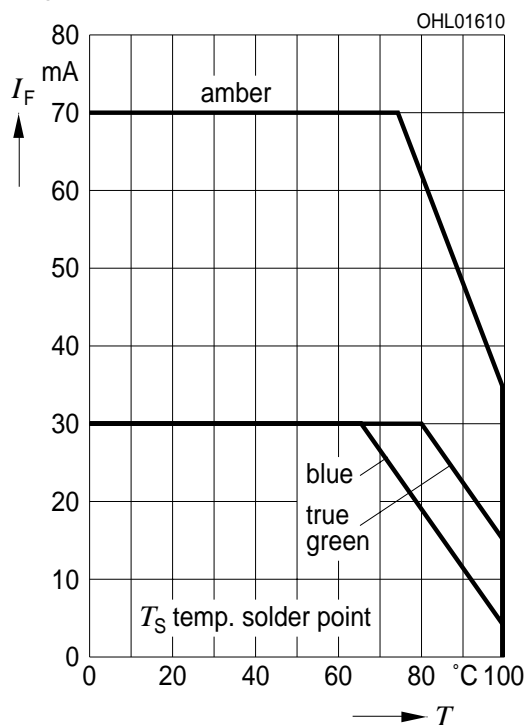

Maximal zulässiger Durchlassstrom $I_F = f(T)$
Max. Permissible Forward Current

3 chips on

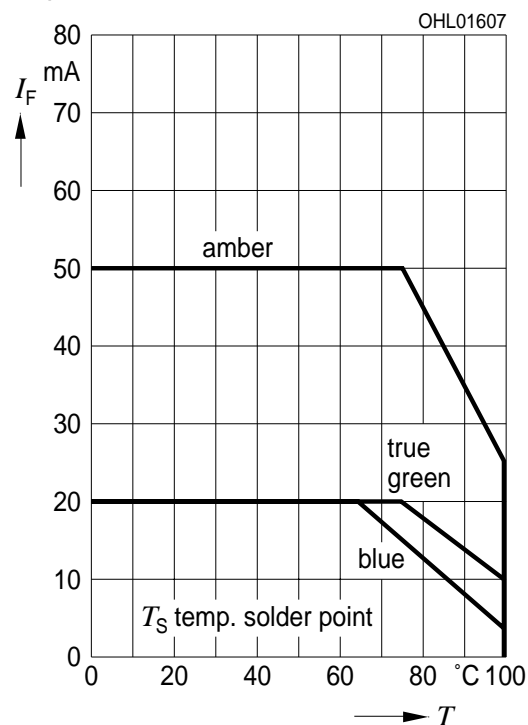

Zulässige Impulsbelastbarkeit $I_F = f(t_p)$
Permissible Pulse Handling Capability
 Duty cycle $D =$ parameter, $T_A = 25\text{ °C}$
amber (1 Chip on)

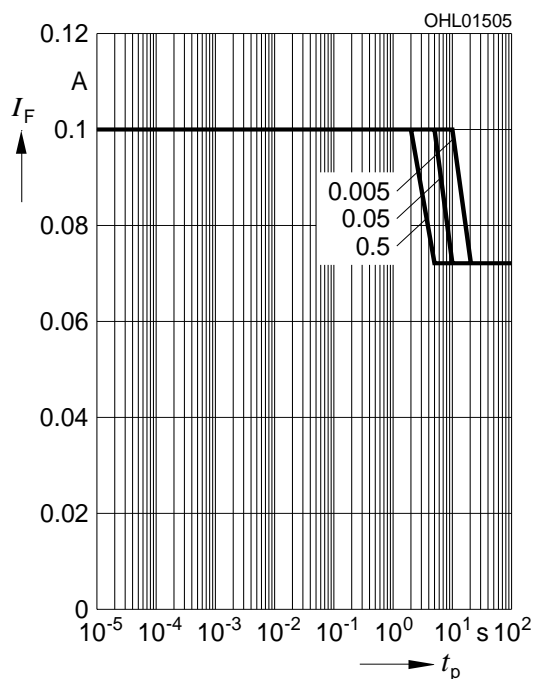

Zulässige Impulsbelastbarkeit $I_F = f(t_p)$
Permissible Pulse Handling Capability
 Duty cycle $D =$ parameter, $T_A = 85\text{ °C}$
amber (1Chip on)

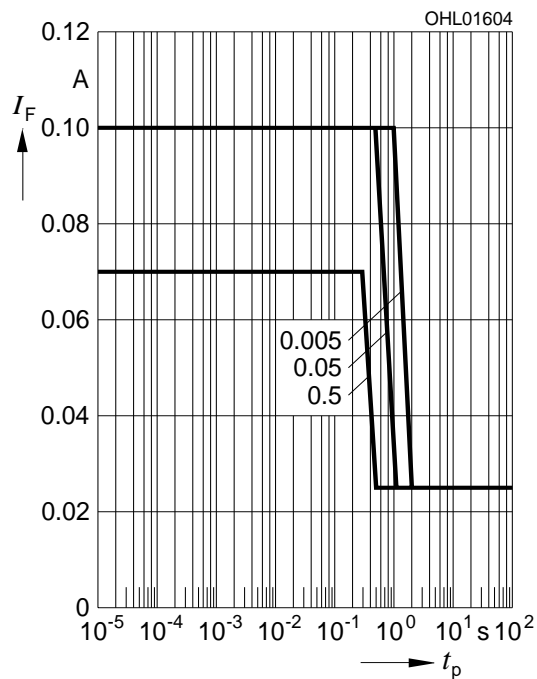

Zulässige Impulsbelastbarkeit $I_F = f(t_p)$
Permissible Pulse Handling Capability
 Duty cycle $D =$ parameter, $T_A = 25\text{ °C}$
amber (3 Chips on)

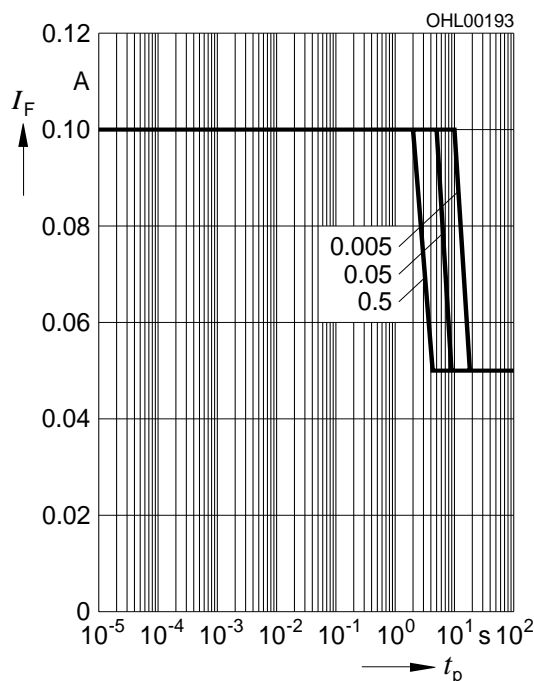

Zulässige Impulsbelastbarkeit $I_F = f(t_p)$
Permissible Pulse Handling Capability
 Duty cycle $D =$ parameter, $T_A = 85\text{ °C}$
amber (3 Chips on)

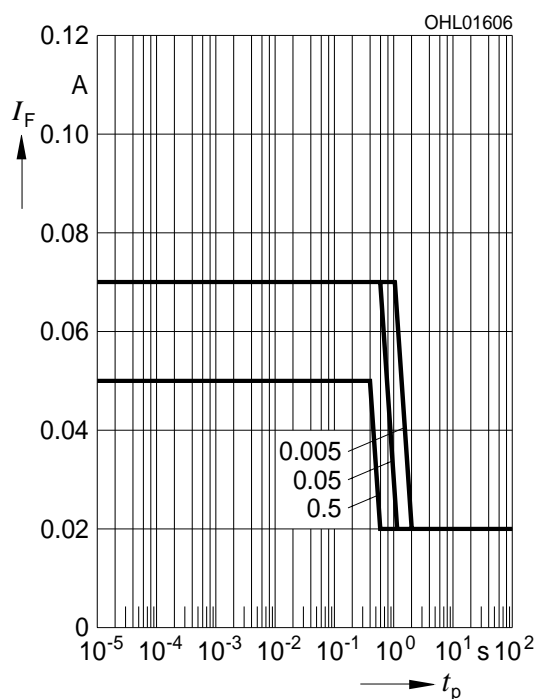

Zulässige Impulsbelastbarkeit $I_F = f(t_p)$
Permissible Pulse Handling Capability
 Duty cycle $D =$ parameter, $T_A = 25\text{ °C}$
 true green (1 Chip on)

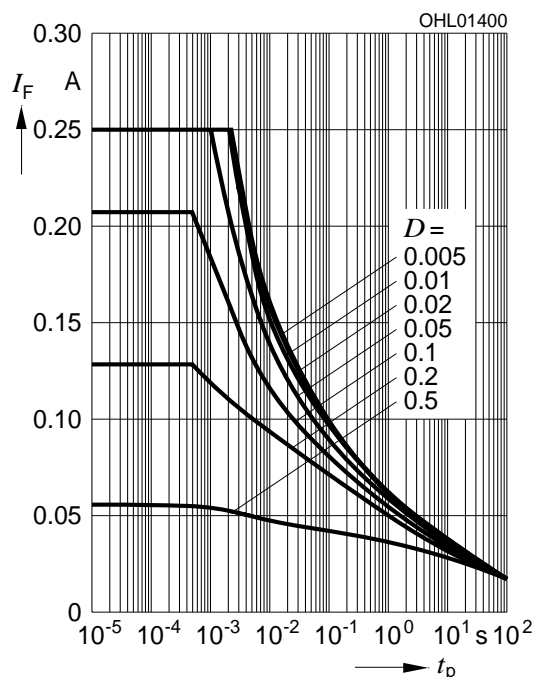

Zulässige Impulsbelastbarkeit $I_F = f(t_p)$
Permissible Pulse Handling Capability
 Duty cycle $D =$ parameter, $T_A = 85\text{ °C}$
 true green (1 Chip on)

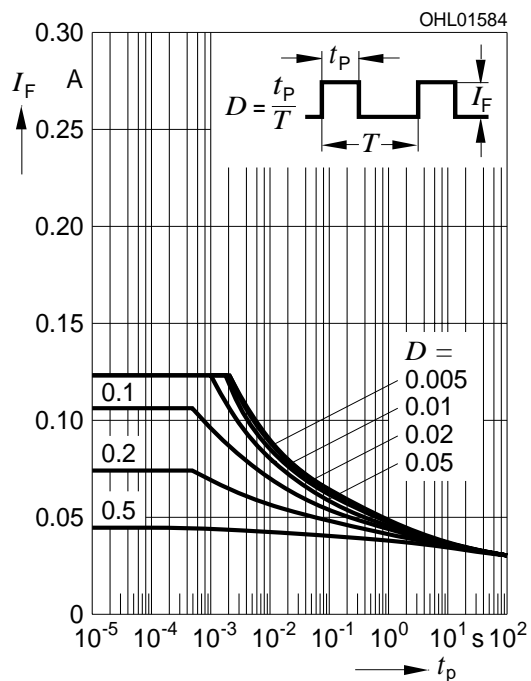

Zulässige Impulsbelastbarkeit $I_F = f(t_p)$
Permissible Pulse Handling Capability
 Duty cycle $D =$ parameter, $T_A = 25\text{ °C}$
 true green (3 Chips on)

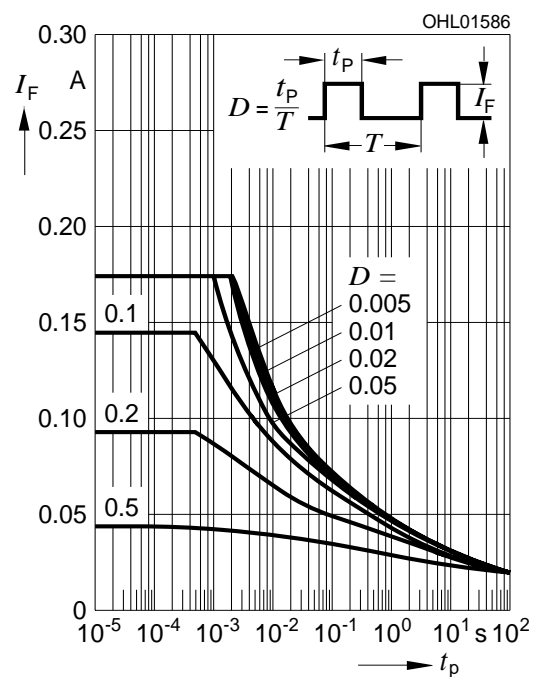

Zulässige Impulsbelastbarkeit $I_F = f(t_p)$
Permissible Pulse Handling Capability
 Duty cycle $D =$ parameter, $T_A = 85\text{ °C}$
 true green (3 Chips on)

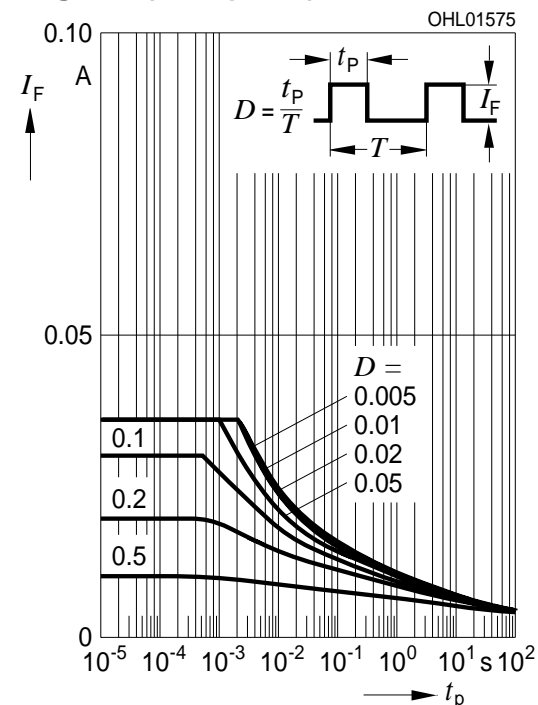

Zulässige Impulsbelastbarkeit $I_F = f(t_p)$
Permissible Pulse Handling Capability
 Duty cycle $D =$ parameter, $T_A = 25\text{ °C}$
blue (1 Chip on)

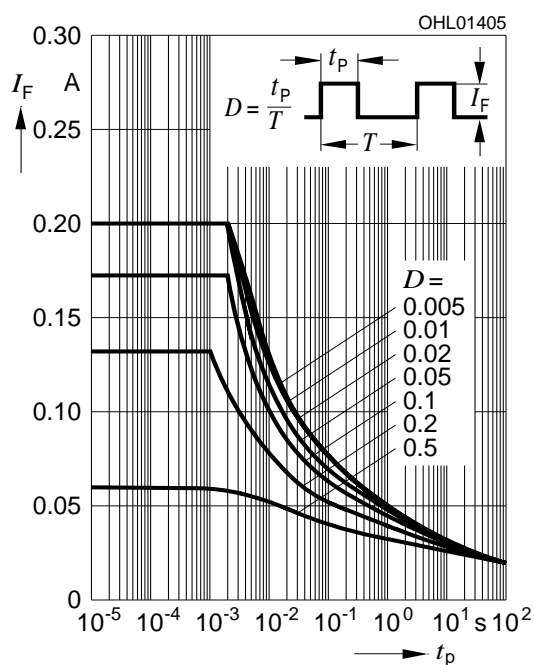

Zulässige Impulsbelastbarkeit $I_F = f(t_p)$
Permissible Pulse Handling Capability
 Duty cycle $D =$ parameter, $T_A = 85\text{ °C}$
blue (1 Chip on)

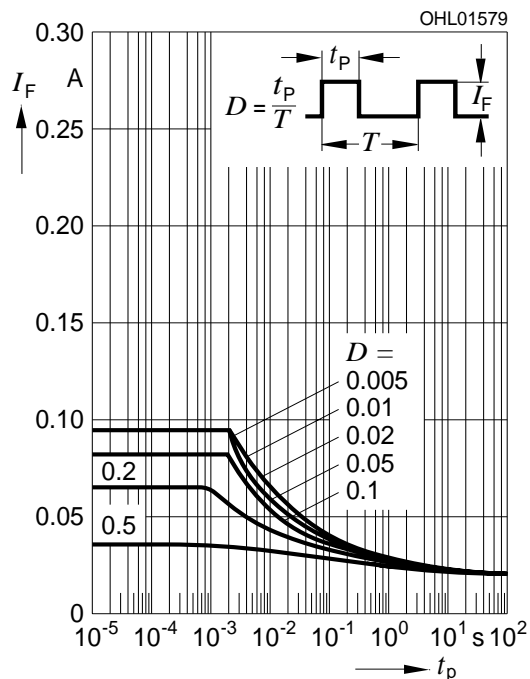

Zulässige Impulsbelastbarkeit $I_F = f(t_p)$
Permissible Pulse Handling Capability
 Duty cycle $D =$ parameter, $T_A = 25\text{ °C}$
blue (3 Chips on)

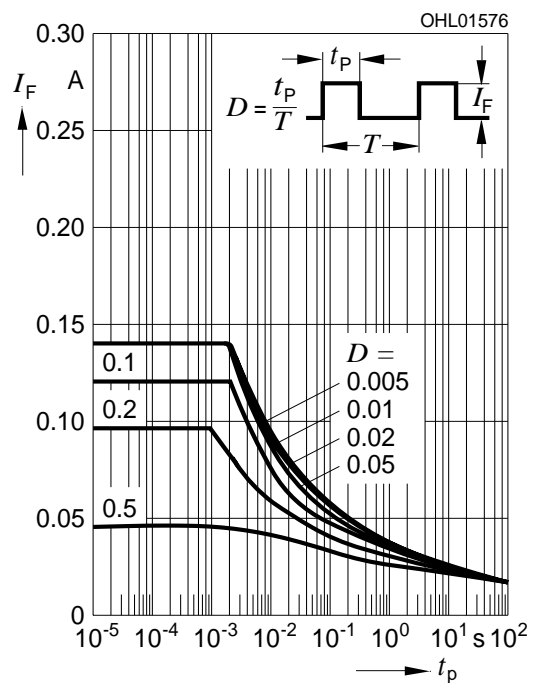

Zulässige Impulsbelastbarkeit $I_F = f(t_p)$
Permissible Pulse Handling Capability
 Duty cycle $D =$ parameter, $T_A = 85\text{ °C}$
blue (3 Chips on)

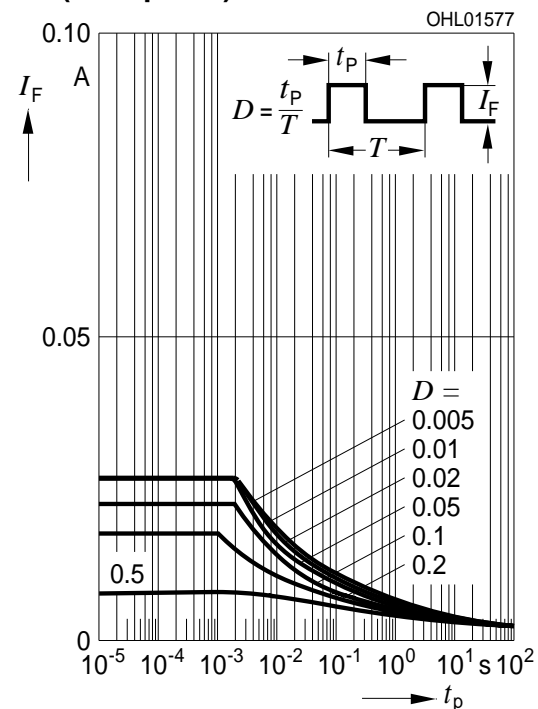

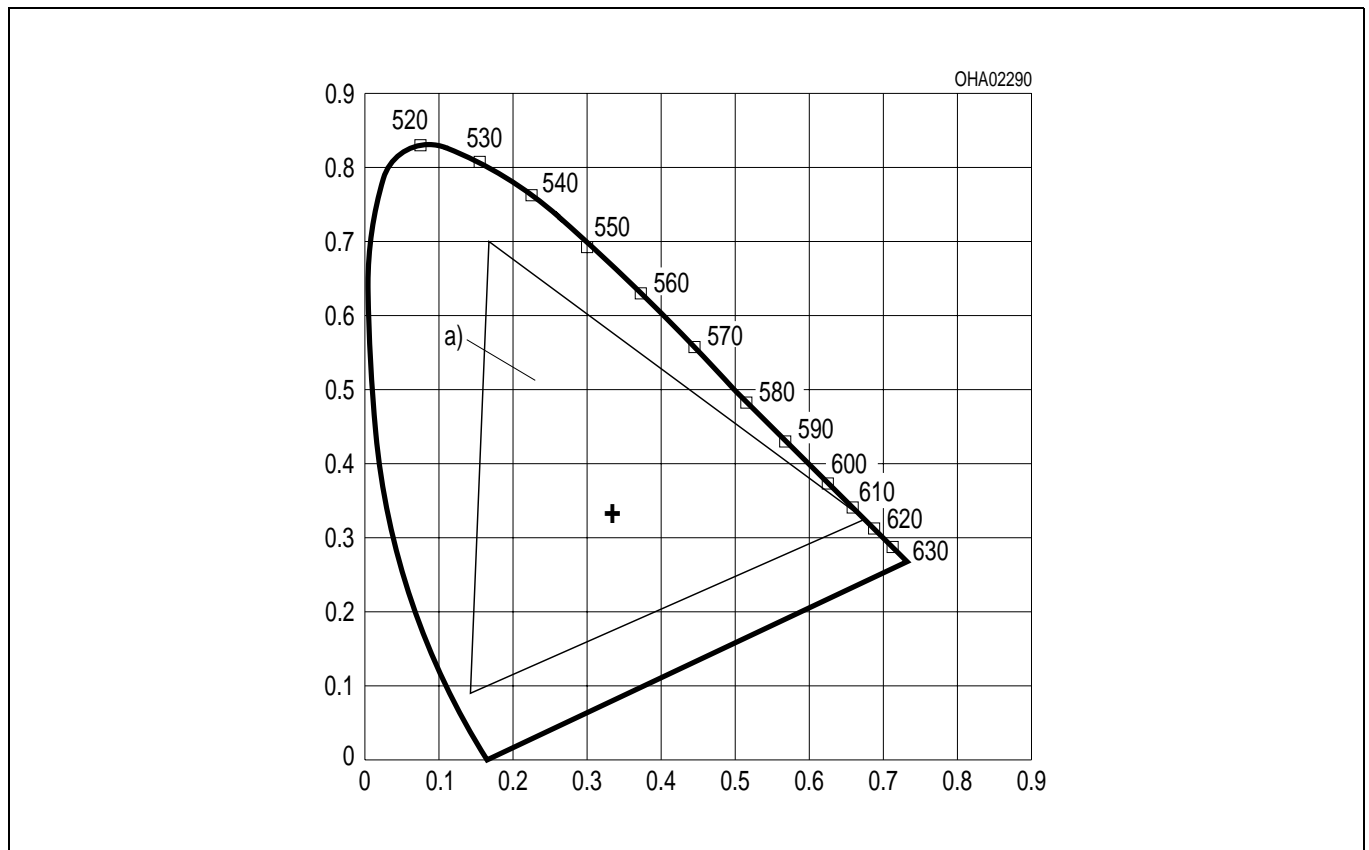

Die Farbkoordinaten des Mischlichtes können innerhalb des mit a) gekennzeichneten Bereichs des Farbdreiecks erwartet werden. Der Unbuntpunkt ($x = 0,33$, $y = 0,33$) ist mit „+“ gekennzeichnet.

The color coordinates of the mixed light can be expected within the area of the color triangle marked a). The achromatic point ($x = 0.33$, $y = 0.33$) is marked „+“.

Maßzeichnung
Package Outlines

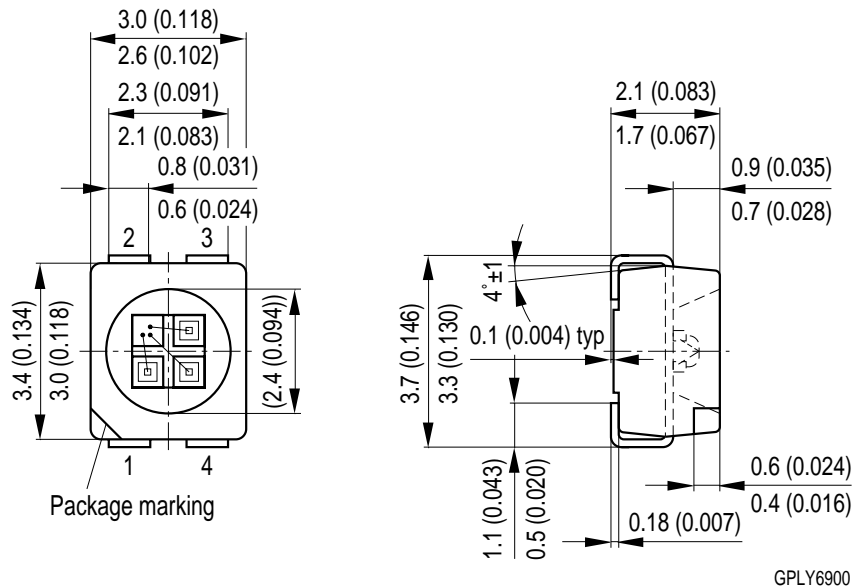

1	Cathode	Amber (A)
2	Anode	A, T, B
3	Cathode	Blue (B)
4	Cathode	True Green (T)

Maße werden wie folgt angegeben: mm (inch) / Dimensions are specified as follows: mm (inch).

Gewicht / Approx. weight: 34 mg

Lötbedingungen Vorbehandlung nach JEDEC Level 2
Soldering Conditions Preconditioning acc. to JEDEC Level 2

IR-Reflow Lötprofil (nach IPC 9501)
IR Reflow Soldering Profile (acc. to IPC 9501)

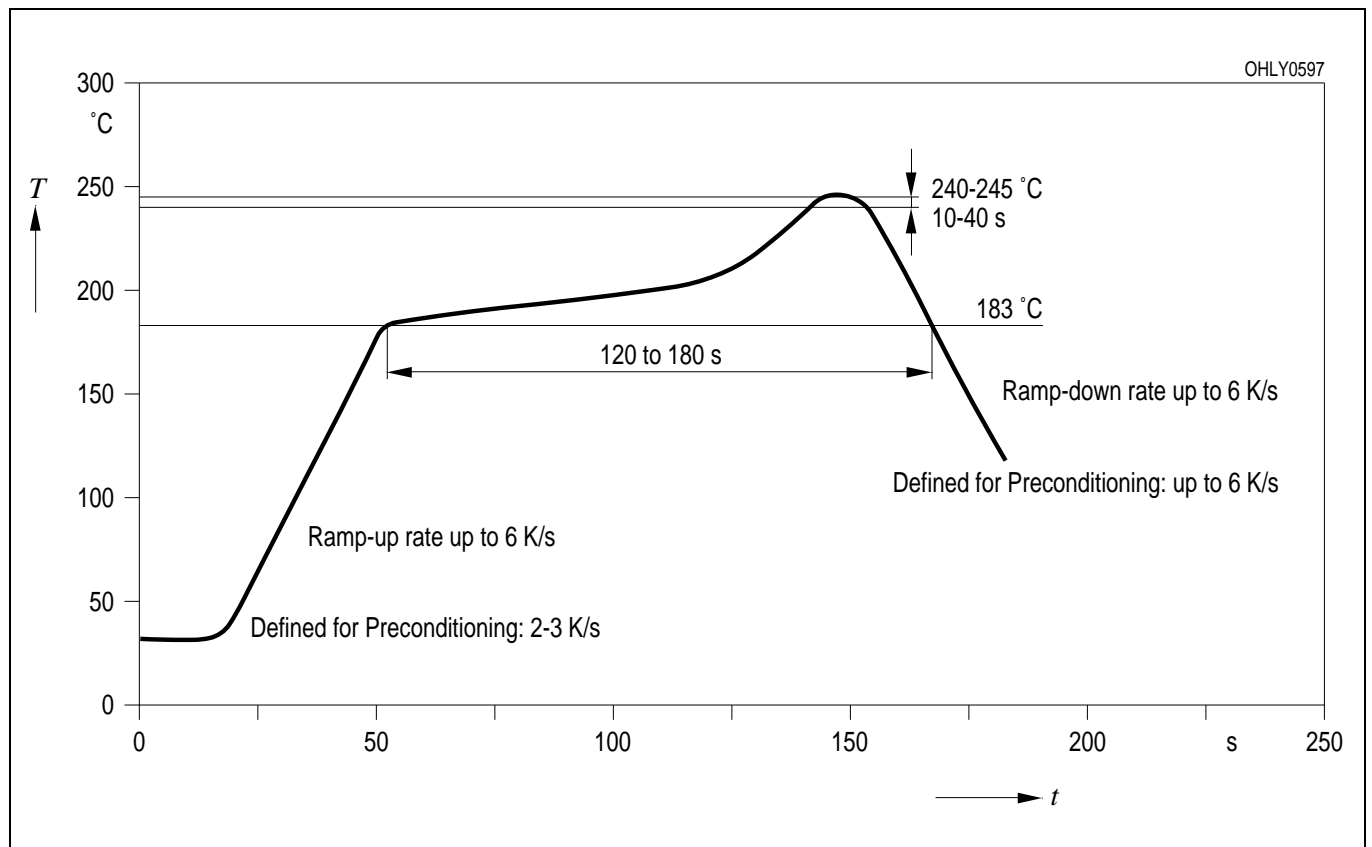

Wellenlöten (TTW) (nach CECC 00802)
TTW Soldering (acc. to CECC 00802)

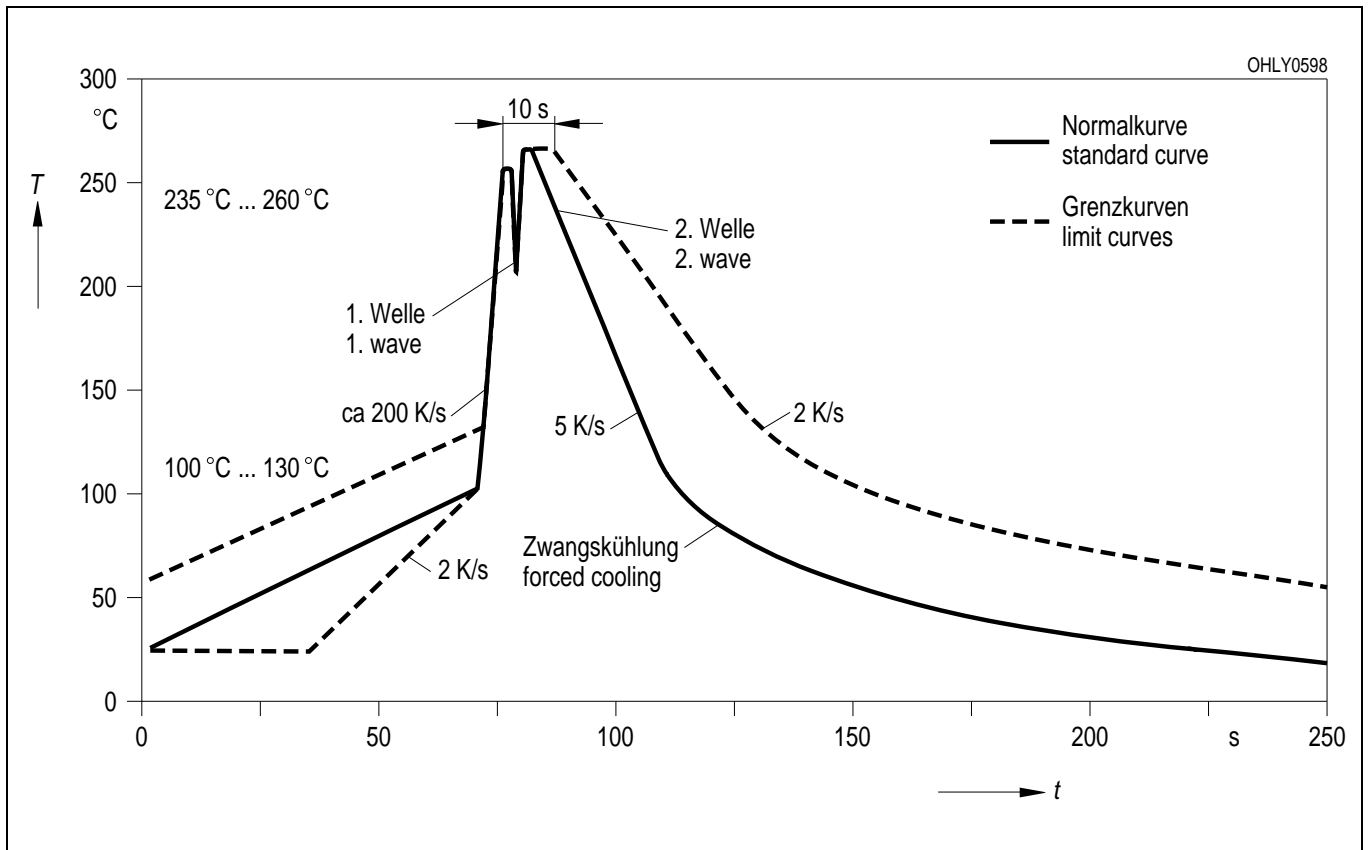

Empfohlenes Lötpad Design IR Reflow Löten
Recommended Solder Pad IR Reflow Soldering

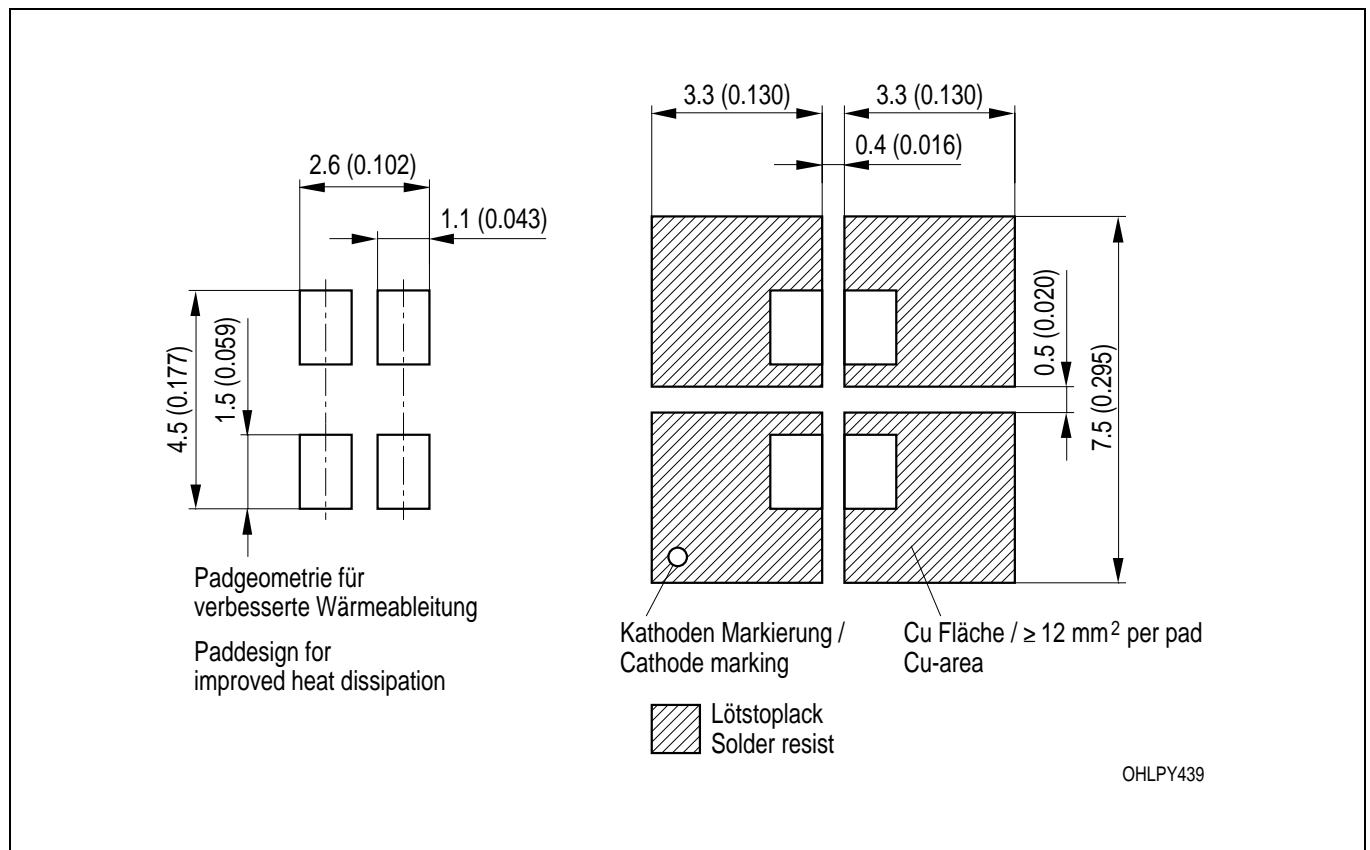

Maße werden wie folgt angegeben: mm (inch) / Dimensions are specified as follows: mm (inch).

Empfohlenes Lötpad Design Wellenlöten (TTW)
Recommended Solder Pad TTW Soldering

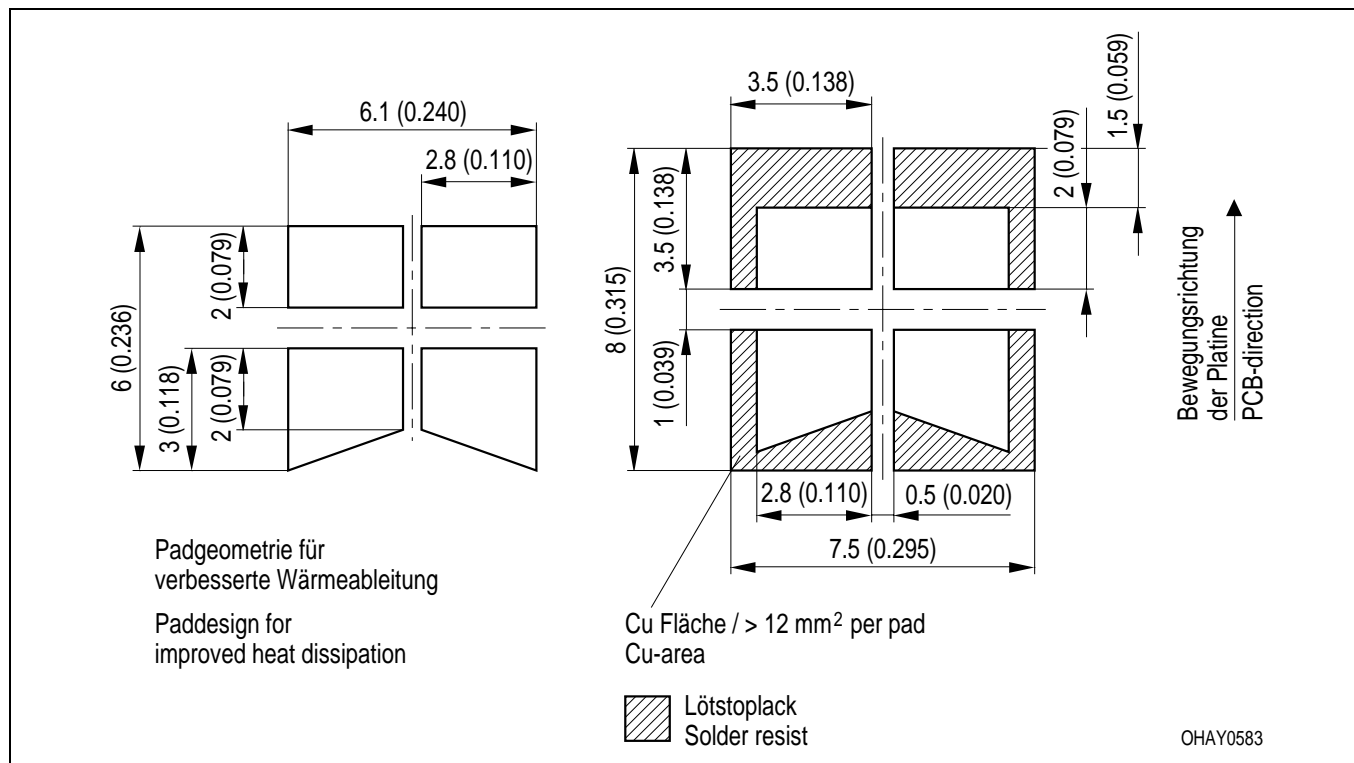

Maße werden wie folgt angegeben: mm (inch) / Dimensions are specified as follows: mm (inch).

Gurtung / Polarität und Lage

Verpackungseinheit 2000/Rolle, ø180 mm
 oder 8000/Rolle, ø330 mm

Method of Taping / Polarity and Orientation

Packing unit 2000/reel, ø180 mm
 or 8000/reel, ø330 mm

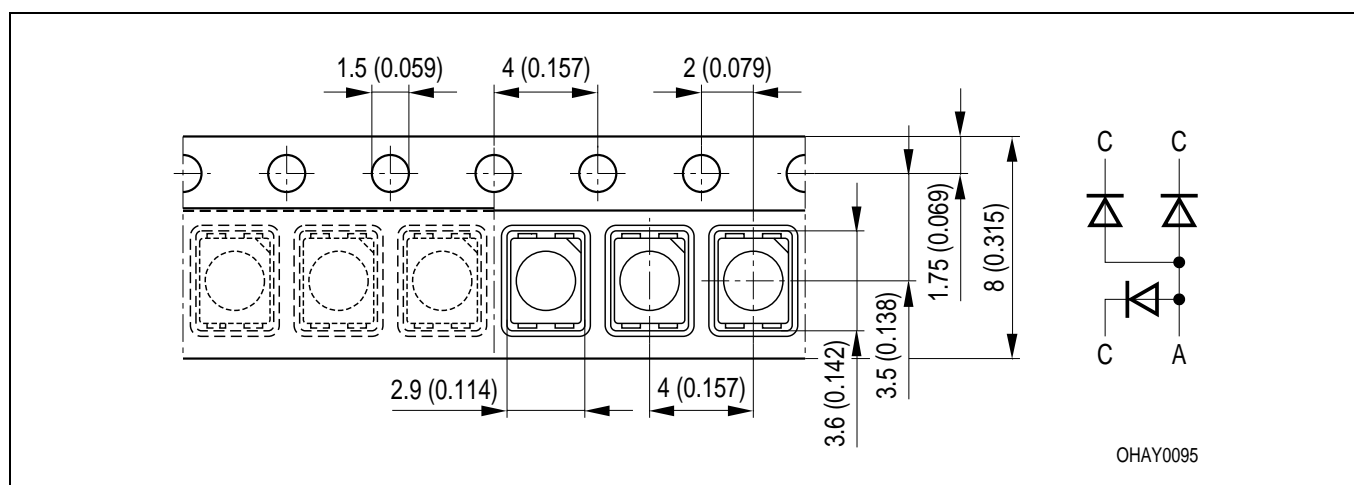

Maße werden wie folgt angegeben: mm (inch) / Dimensions are specified as follows: mm (inch).

Revision History: 2002-05-24

Previous Version: 2001-11-30

Page	Subjects (major changes since last revision)
1	ESD-withstand voltage
2	ordering informaion
5	grouping information

Published by OSRAM Opto Semiconductors GmbH & Co. OHG
Wernerwerkstrasse 2, D-93049 Regensburg

© All Rights Reserved.

Attention please!

The information describes the type of component and shall not be considered as assured characteristics. Terms of delivery and rights to change design reserved. Due to technical requirements components may contain dangerous substances. For information on the types in question please contact our Sales Organization. If printed or downloaded, please find the latest version in the Internet.

Packing

Please use the recycling operators known to you. We can also help you – get in touch with your nearest sales office. By agreement we will take packing material back, if it is sorted. You must bear the costs of transport. For packing material that is returned to us unsorted or which we are not obliged to accept, we shall have to invoice you for any costs incurred.

Components used in life-support devices or systems must be expressly authorized for such purpose! Critical components ¹ may only be used in life-support devices or systems ² with the express written approval of OSRAM OS.

¹ A critical component is a component used in a life-support device or system whose failure can reasonably be expected to cause the failure of that life-support device or system, or to affect its safety or the effectiveness of that device or system.

² Life support devices or systems are intended (a) to be implanted in the human body, or (b) to support and/or maintain and sustain human life. If they fail, it is reasonable to assume that the health of the user may be endangered.