

■Features

- High Luminous Super Flux Output
- Superior Weather-resistance
- UV Resistant Epoxy
- Long Lifetime Operation
- Water Clear Type

■Applications

- General Purpose Indicators
- Small Area Illuminations
- Back Lighting
- Other Lighting

■Outline Dimension

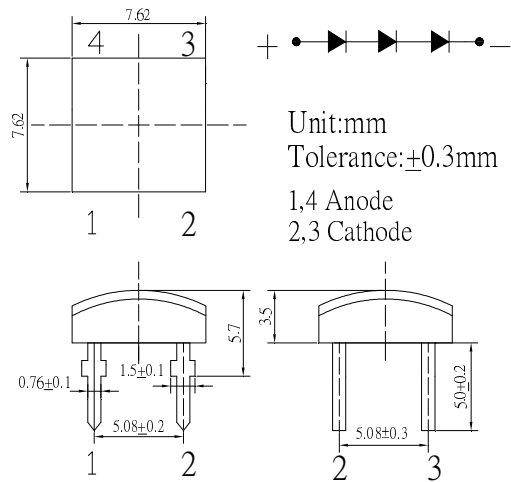

■Absolute Maximum Rating

(Ta=25°C)

Item	Symbol	Value	Unit
DC Forward Current	I _F	50	mA
Pulse Forward Current*	I _{FP}	100	mA
Reverse Voltage	V _R	15	V
Power Dissipation	P _D	450	mW
Operating Temperature	T _{opr}	-30 ~ +85	°C
Storage Temperature	T _{stg}	-40 ~ +100	°C
Lead Soldering Temperature	T _{sol}	260°C / 5sec	-

■Directivity

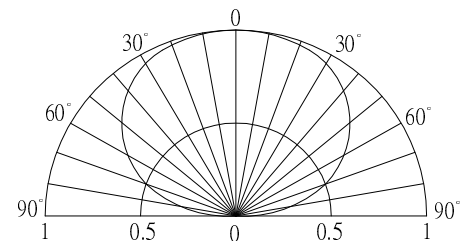

*Pulse width Max.10ms , Duty ratio max 1/10

■Electrical -Optical Characteristics

(Ta=25°C)

Item	Symbol	Condition	Min.	Typ.	Max.	Unit
DC Forward Voltage	V _F	I _F =30mA	8.9	9.3	10.8	V
DC Reverse Current	I _R	V _R =15V	-	-	10	μA
Luminous Flux*	Φ _v	I _F =30mA	-	25	-	lm
Luminous Intensity*	I _v	I _F =30mA	5500	7500	-	mcd
Color Temperature	CCT	I _F =30mA	-	3000	-	K
Chromaticity Coordinates*	x	I _F =30mA	-	0.45	-	
	y	I _F =30mA	-	0.41	-	
50% Power Angle	2θ _{1/2}	I _F =30mA	-	140	-	deg

*1 Tolerance of chromaticity coordinates is ±10%

*2 Tolerance of luminous intensity is ±15%