

■Features

- High Luminous Super Flux Output
- Superior Weather-resistance
- UV Resistant Epoxy
- Long Lifetime Operation
- Water Clear Type

■Applications

- General Purpose Indicators
- Small Area Illuminations
- Back Lighting
- Other Lighting

■Outline Dimension

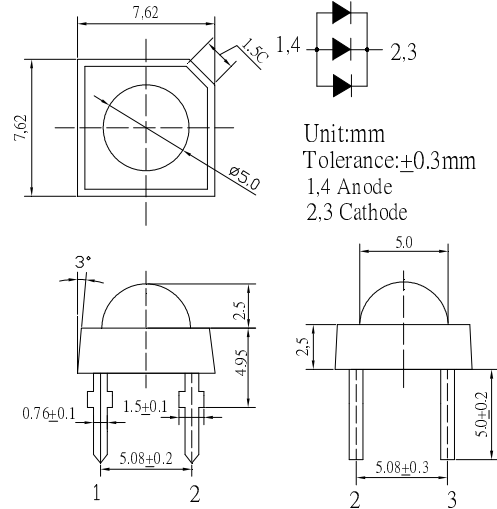

■Absolute Maximum Rating

(Ta=25°C)

Item	Symbol	Value	Unit
DC Forward Current	I _F	90	mA
Pulse Forward Current*	I _{FP}	360	mA
Reverse Voltage	V _R	5	V
Power Dissipation	P _D	324	mW
Operating Temperature	T _{opr}	-30 ~ +85	°C
Storage Temperature	T _{stg}	-40 ~ +100	°C
Lead Soldering Temperature	T _{sol}	260°C / 5sec	-

*Pulse width Max.10ms , Duty ratio max 1/10

■Directivity

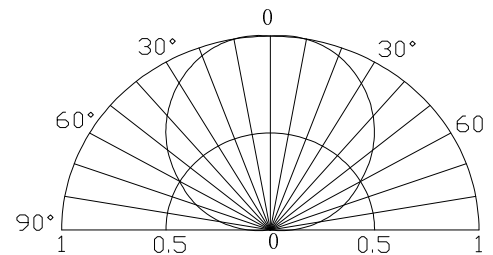

■Electrical -Optical Characteristics

(Ta=25°C)

Item	Symbol	Condition	Min.	Typ.	Max.	Unit
DC Forward Voltage	V _F	I _F =90mA	2.9	3.1	3.6	V
DC Reverse Current	I _R	V _R =5V	-	-	30	μA
Luminous Flux*	Φ _v	I _F =90mA	-	25	-	lm
Color Temperature	CCT	I _F =90mA	-	3800	-	K
Chromaticity Coordinates*	x	I _F =90mA	-	0.38	-	
	y	I _F =90mA	-	0.39	-	
50% Power Angle	2θ _{1/2}	I _F =90mA	-	120	-	deg

*1 Tolerance of chromaticity coordinates is ±10%

*2 Tolerance of luminous intensity is ±15%