

■Features

- High Luminous LEDs
- 5mm Standard Directivity
- Superior Weather-resistance
- UV Resistant Epoxy
- Water Clear Type

■Applications

- Automotive Dashboard Lighting
- Money Detector
- Back Lighting
- Other Lighting

■Outline Dimension

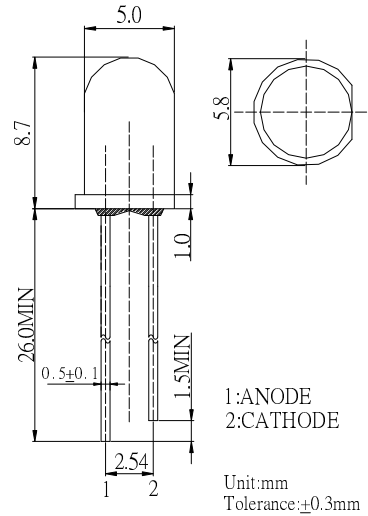

■Absolute Maximum Rating

(Ta=25°C)

Item	Symbol	Value	Unit
DC Forward Current	I_F	30	mA
Pulse Forward Current*	I_{FP}	100	mA
Reverse Voltage	V_R	5	V
Power Dissipation	P_D	114	mW
Operating Temperature	T_{opr}	-30 ~ +85	°C
Storage Temperature	T_{stg}	-40 ~ +100	°C
Lead Soldering Temperature	T_{sol}	260°C/5sec	-

■Directivity

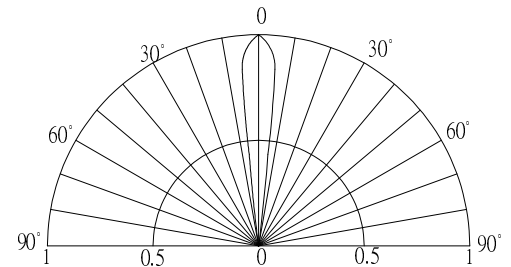

*Pulse width Max.10ms Duty ratio max 1/10

■Electrical -Optical Characteristics

(Ta=25°C)

Item	Symbol	Condition	Min.	Typ.	Max.	Unit
DC Forward Voltage	V_F	$I_F=20mA$	3.0	3.4	3.8	V
DC Reverse Current	I_R	$V_R=5V$	-	-	10	μA
Peak Wavelength	λ_p	$I_F=20mA$	410	415	420	nm
Radiant flux*	Φ_e	$I_F=20mA$	2.0	5.0	6.0	mW
50% Power Angle	$2\theta_{1/2}$	$I_F=20mA$	-	15	-	deg

*1 Tolerance of dominant wavelength is $\pm 1nm$

*2 Tolerance of Radiant flux is $\pm 15\%$