

版本：V2.2

本圖面若與目錄之規格尺寸不符，以本圖面規格尺寸為主。
Below is our main specification if different from catalog.

RoHS compliant

參考資料

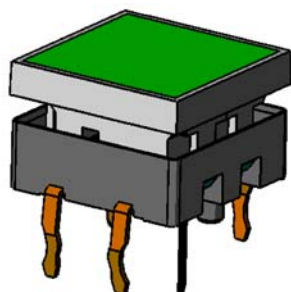
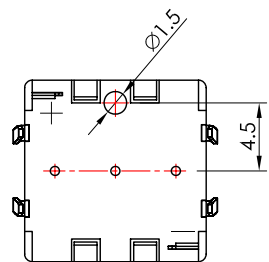
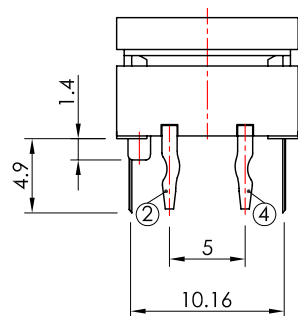
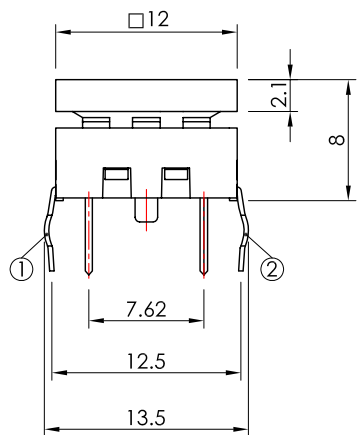

LED CONFIGURATION

CONTACT CONFIGURATION

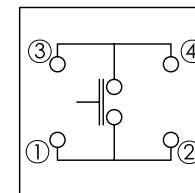
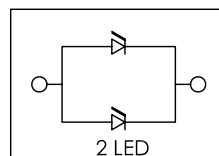
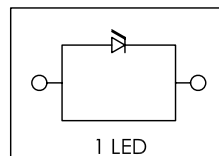

LED COLOR	
00	Without LED
01	Red
5V1	Red 5V DC
02	Yellow
5V2	Yellow 5V DC
S2	Super Yellow
03	Green
5V3	Green 5V DC
S3	Super Green
P3	Pure Green
P3S	Pure Green(single)
04	White
4S	White(single)
07	Blue
7S	Blue(single)

CAP COLOR	
1	Red
2	Yellow
3	Green
4	White
5	Transparent
6	Orange
7	Blue

P.C.B. MOUNTING HOLES

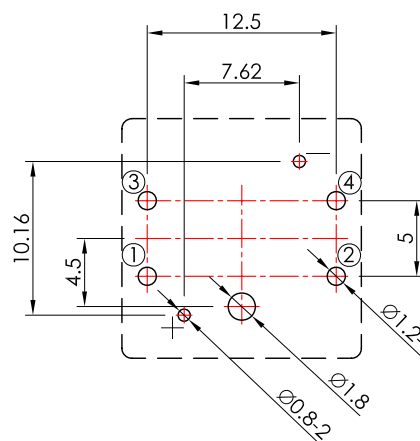

RoHS compliant

SPECIFICATION

Circuit: 1P1T.
Rating: 50mA 12V DC.
Contact resistance: 100mΩ Max.(initial)
Insulation resistance: 100MΩ Min.
Operating force: 250±50g.
Total travel: 0.3±0.1mm.
Life: 5,000,000 Cycles Min.
Operating temperature: -25°C ~ +60°C.
Soldering temperature: 250°C Max for 3 Sec.

MATERIAL

Cap: PC.
Cover: PC.
Base: Nylon.
Housing: PC.
Lamp term: PBS+Au or Ag.
Act dome: PBS+Ag.
End term: Brass+Au or Ag.
Led: Surface mount chip LED lamps.

ST-12-XXXXXXX-G

COVER
refer to our catalog

MARKING
refer to our catalog



V2.1	無	圖框改版及SPEC、尺寸修改	2007.03.29
V2.0	無	新繪製	2004.11.15
版本 VER.	符號 SYMBOL	修改內容 ALTERATION	更新日期 DATE

產品 PRODUCT		型號 MODEL NO.	
Pushbutton Switch		ST-12-XXXXXXX -G	
製圖 DRAWN BY	核圖 CHECKED BY	主管 APPROVED BY	單位 UNIT
Nail Chen	Alex Lin	Margaret Lee	mm
		比例 SCALE	2 : 1
		公差 TOLERANCE	.X=±0.3mm, .XX=±0.2mm

SWITRONIC
INDUSTRIAL CORP.
Switches



一綺電子企業股份有限公司

總公司：110 台北市信義路四段415號12樓之2
12F-2 NO. 415, SEC. 4, HSIIN YI ROAD, TAIPEI (110), TAIWAN
TEL: 886-2-27290229 (Rep.) FAX: 886-2-27582086
URL: http://www.switronic.com.tw
E-MAIL: switches@ms36.hinet.net

版本：V2.2

本圖面若與目錄之規格尺寸不符，以本圖面規格尺寸為主。
Below is our main specification if different from catalog.

RoHS compliant

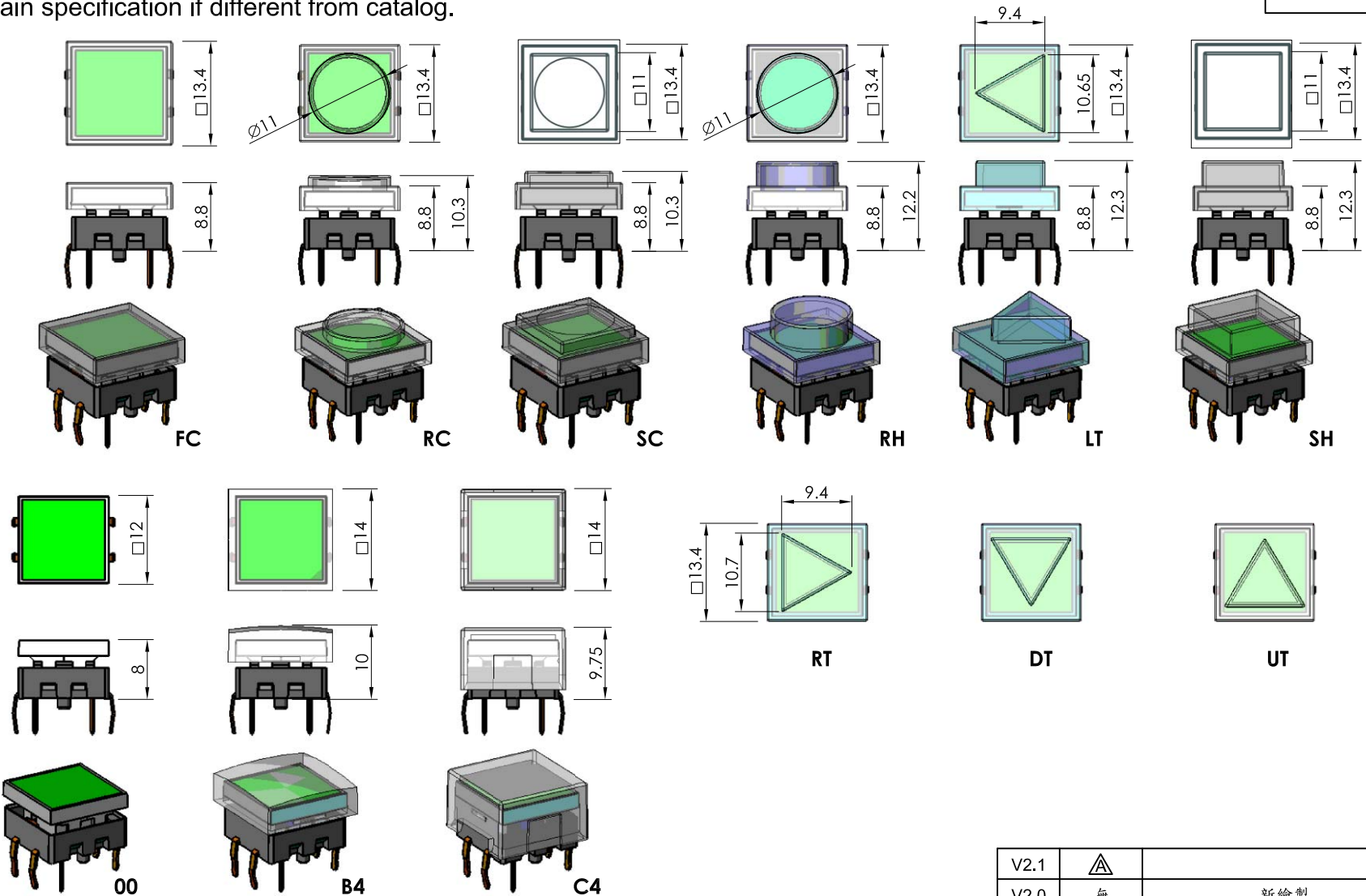

V2.1	△		
V2.0	無	新繪製	2007.03.29
版本 VER.	符號 SYMBOL	修改內容 ALTERATION	更新日期 DATE

產品 PRODUCT		Cover		型號 MODEL NO.		ST-12 SERIES COVER	
製圖 DRAWN BY	核圖 CHECKED BY	主管 APPROVED BY		單位 UNIT	mm		
Nail Chen	Alex Lin	Margaret Lee		比例 SCALE	1.2 : 1		
				公差 TOLERANCE	.X=±0.3mm, .XX=±0.2mm		

SWITRONIC[®]
INDUSTRIAL CORP.
Switches



一綺電子企業股份有限公司
總公司：110 台北市信義路四段415號12樓之2
12F-2 NO. 415, SEC. 4, HSIN YI ROAD, TAIPEI (110), TAIWAN
TEL: 886-2-27290229 (Rep.) FAX: 886-2-27582086
URL: http://www.switronic.com.tw
E-MAIL: switches@ms36.hinet.net