



# SX32F SERIES

## SCHOTTKY BARRIER RECTIFIER

**VOLTAGE** 20-60 Volts **CURRENT** 3 Amperes

### FEATURES

- Plastic package has Underwriters Laboratory Flammability Classification 94V-0
- For surface mounted applications
- Low profile package
- Built-in strain relief
- Metal to silicon rectifier. majority carrier conduction
- Low power loss,high efficiency
- High surge capacity
- For use in low voltage high frequency inverters, free wheeling, and polarity protection applications
- Lead free in comply with EU RoHS 2002/95/EC directives.
- Green molding compound as per IEC61249 Std. . (Halogen Free)

### MECHANICAL DATA

Case : SMAF, Plastic

Terminals : Solderable per MIL-STD-750, Method 2026

Polarity: Color band denotes cathode end

Weight: 0.0011 ounces, 0.0328 grams



### SMAF

Unit : inch(mm)

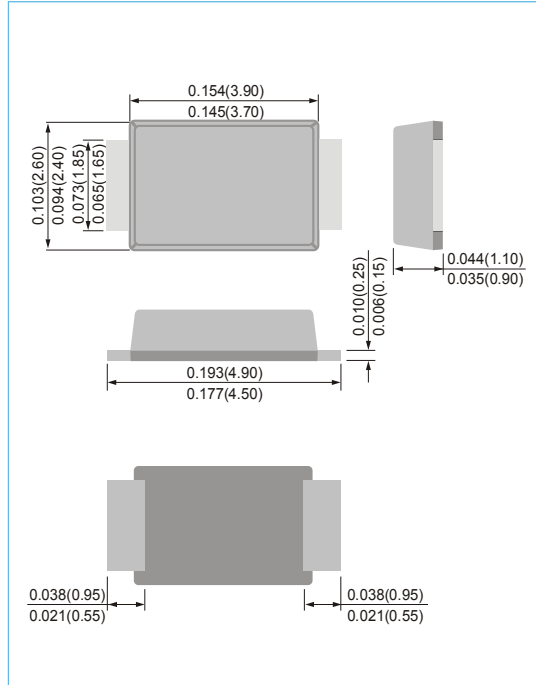

### MAXIMUM RATINGS AND ELECTRICAL CHARACTERISTICS (T<sub>A</sub>=25°C unless otherwise noted)

PARAMETER	SYMBOL	SX32F	SX33F	SX34F	SX35F	SX36F	UNITS
Recurrent Peak Reverse Voltage	V <sub>RRM</sub>	20	30	40	50	60	V
RMS Voltage	V <sub>RMS</sub>	14	21	28	35	42	V
DC Blocking Voltage	V <sub>R</sub>	20	30	40	50	60	V
Average Forward Current	I <sub>F(AV)</sub>	3.0					A
Peak Forward Surge Current : 8.3ms single half sine-wave superimposed on rated load(JEDEC method)	I <sub>FSM</sub>	80					A
Forward Voltage at 3.0A	V <sub>F</sub>	0.5		0.75			V
DC Reverse Current at Rated DC Blocking Voltage	I <sub>R</sub>	100					μA
Typical Junction capacitance	C <sub>J</sub>	485		150			pF
Typical Thermal Resistance ,Junction to Lead (Note 1) Junction to Ambient (Note 2)	R <sub>θJL</sub> R <sub>θJA</sub>	20 150					°C / W
Operating Junction Temperature and Storage Temperature Range	T <sub>J</sub> , T <sub>STG</sub>	-55 to +150					°C

### NOTES :

- 1.Mounted on an FR4 PCB, single-sided copper, with 48cm<sup>2</sup>copper pad area.
- 2.Mounted on an FR4 PCB, single-sided copper, mini pad.



# SX32F SERIES

## RATING AND CHARACTERISTIC CURVES

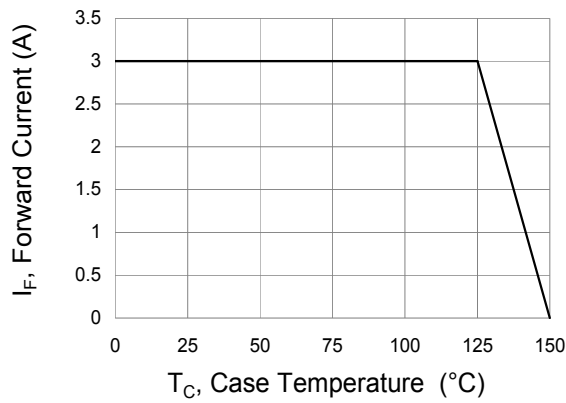

Fig.1 Forward Current Derating Curve

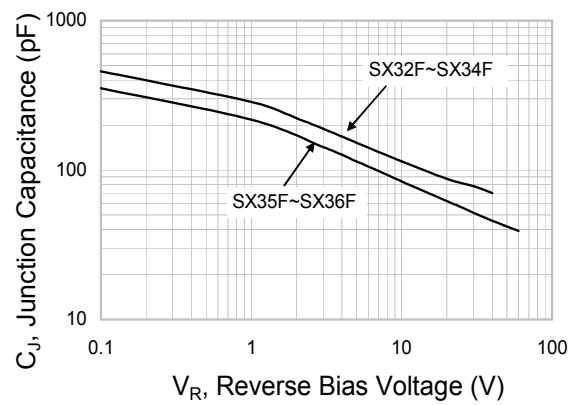

Fig.2 Typical Junction Capacitance

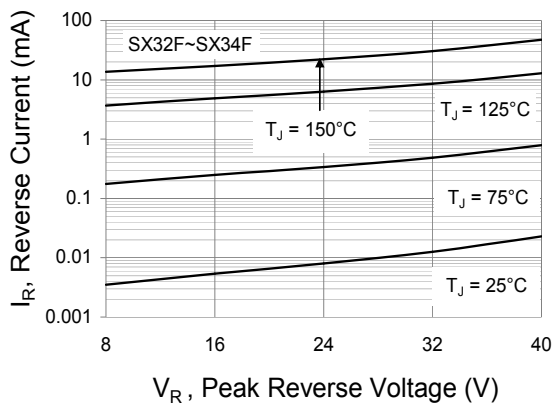

Fig.3 Typical Reverse Characteristics

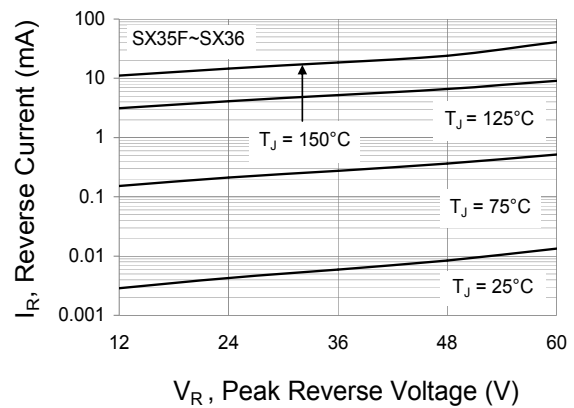

Fig.4 Typical Reverse Characteristics

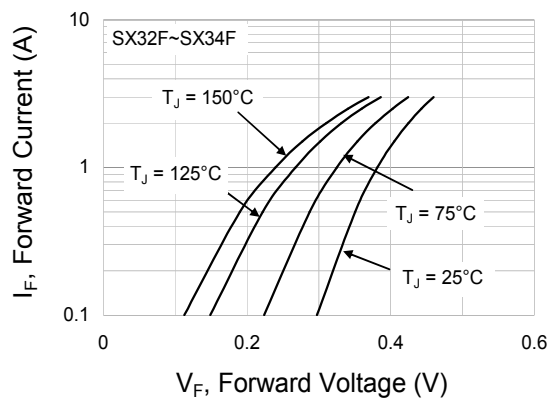

Fig.5 Typical Forward Characteristics

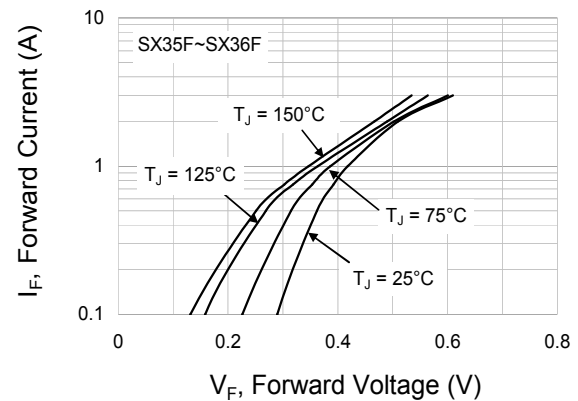
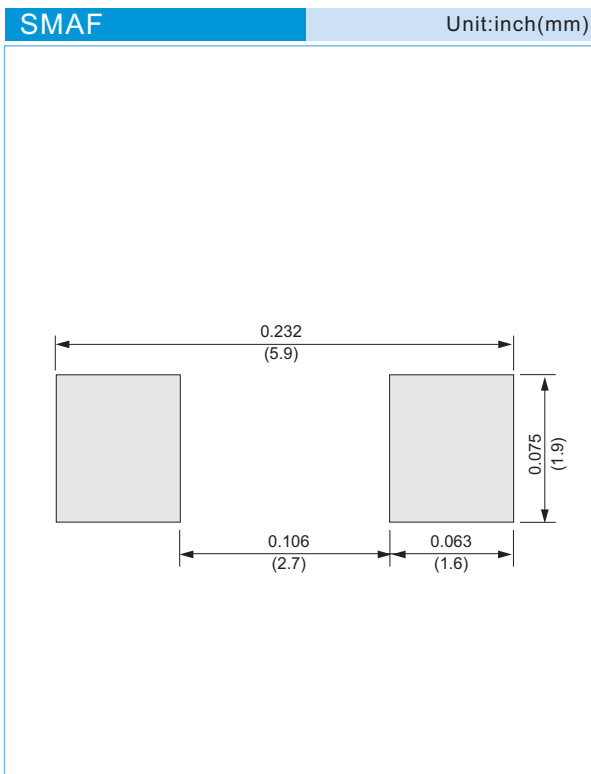

Fig.6 Typical Forward Characteristics



# SX32F SERIES

## MOUNTING PAD LAYOUT



## ORDER INFORMATION

- Packing information
  - T/R - 10K per 13" plastic Reel
  - T/R - 3K per 7" plastic Reel

## LEGAL STATEMENT

### Copyright PanJit International, Inc 2012

The information presented in this document is believed to be accurate and reliable. The specifications and information herein are subject to change without notice. Pan Jit makes no warranty, representation or guarantee regarding the suitability of its products for any particular purpose. Pan Jit products are not authorized for use in life support devices or systems. Pan Jit does not convey any license under its patent rights or rights of others.



## SX32F SERIES

Part No\_packing code\_Version

SX32F\_R1\_00001

SX32F\_R2\_00001

For example :

RB500V-40\_R2\_00001



Packing Code <b>XX</b>				Version Code <b>XXXXX</b>		
Packing type	1 <sup>st</sup> Code	Packing size code	2 <sup>nd</sup> Code	HF or RoHS	1 <sup>st</sup> Code	2 <sup>nd</sup> ~5 <sup>th</sup> Code
T/B	<b>A</b>	N/A	<b>0</b>	HF	<b>0</b>	serial number
T/R	<b>R</b>	7"	<b>1</b>	RoHS	<b>1</b>	serial number
B/P	<b>B</b>	13"	<b>2</b>			
T/P	<b>T</b>	26mm	<b>X</b>			
TRR	<b>S</b>	52mm	<b>Y</b>			
TRL	<b>L</b>	PBCU	<b>U</b>			
FORMING	<b>F</b>	PBCD	<b>D</b>			



## SX32F SERIES

---

### Disclaimer

- Reproducing and modifying information of the document is prohibited without permission from Panjit International Inc..
- Panjit International Inc. reserves the rights to make changes of the content herein the document anytime without notification. Please refer to our website for the latest document.
- Panjit International Inc. disclaims any and all liability arising out of the application or use of any product including damages incidentally and consequentially occurred.
- Panjit International Inc. does not assume any and all implied warranties, including warranties of fitness for particular purpose, non-infringement and merchantability.
- Applications shown on the herein document are examples of standard use and operation. Customers are responsible in comprehending the suitable use in particular applications. Panjit International Inc. makes no representation or warranty that such applications will be suitable for the specified use without further testing or modification.
- The products shown herein are not designed and authorized for equipments requiring high level of reliability or relating to human life and for any applications concerning life-saving or life-sustaining, such as medical instruments, transportation equipment, aerospace machinery et cetera. Customers using or selling these products for use in such applications do so at their own risk and agree to fully indemnify Panjit International Inc. for any damages resulting from such improper use or sale.